

LED
LED
LED



LED

Das Licht der Zukunft jetzt schon in der Gegenwart!

Enjoy the lighting
of the future – today

*La lumière de l'avenir déjà
dans le monde présent!*

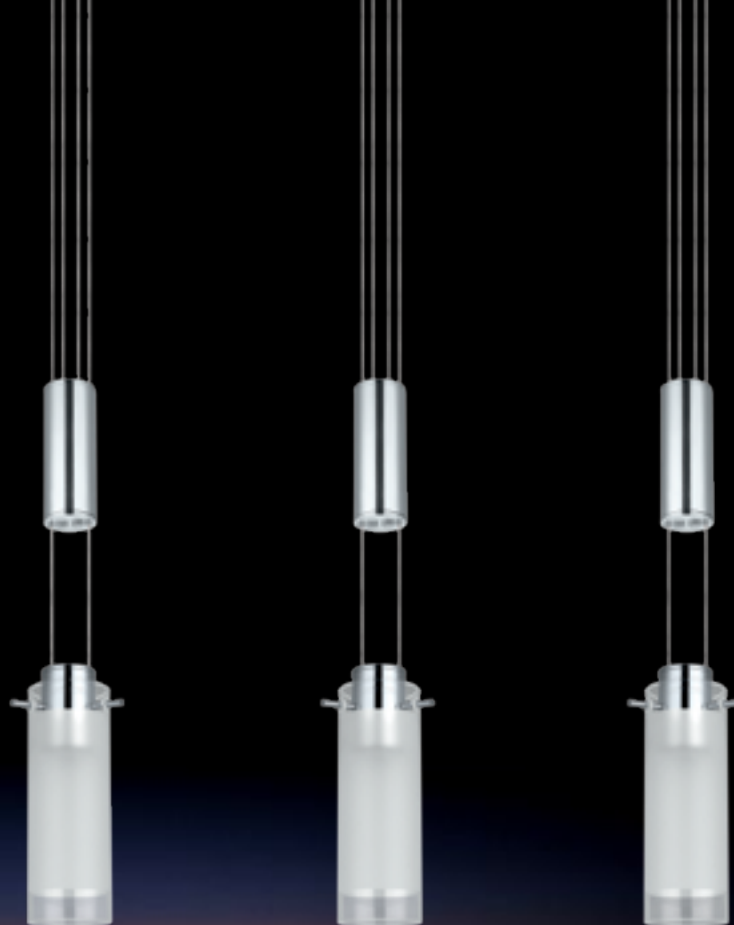

Die Vorteile liegen klar auf der Hand:

- LEDs verbrauchen bis zu 80 % weniger Energie gegenüber herkömmlichen Leuchtmitteln und das bei einer Lebensdauer von bis zu 25 Jahren (=25.000 Betriebsstunden).
- LEDs können beliebig ein- und ausgeschaltet werden ohne die Lebensdauer zu verkürzen.
- LEDs sind praktisch wartungsfrei, stoßfest und unempfindlich gegen Erschütterungen. Außerdem benötigen sie keine Startzeiten, das heißt: Volle Lichtstärke unmittelbar beim Einschalten.
- LEDs geben ein warmes gleichmäßiges Licht ab und sind sowohl mit Farbwechsler als auch dimmbar erhältlich.

Nicht zuletzt aus diesen Gründen hat sich EGLO für die Lichtsaison 2011/2012 intensiv mit dem Thema LED befasst und eine breite Produktpalette zusammen gestellt, die für jeden etwas bietet: von der Designer-Hängeleuchte, über die Allzweck-Deckenleuchte bis hin zur trendigen Tischleuchte.

The advantages are plain to see:

- LEDs use up to 80% less energy compared to conventional bulbs and have a lifespan of up to 25 years (= 25,000 operating hours).
- LEDs can be switched on/off unlimited times without shortening their lifetime.
- LEDs are practically maintenance-free, shock-proof and unaffected by vibrations. You also don't need to wait for them to start up, which means full-strength light as soon as they are switched on.
- LEDs provide warm, even light and are available with both colour changers and dimmer switches.

For all of these reasons, EGLO has worked intensively on LED technology for the 2011/2012 lighting season, manufacturing a wide range of products that has something for everyone: from designer suspension lights, to all-purpose ceiling lights and even trendy table lamps.

Les avantages sont évidents :

- Les LED consomment jusqu'à 80 % d'énergie de moins que les ampoules traditionnelles, et ce, avec une durée de vie allant jusqu'à 25 ans (=25 000 heures de fonctionnement).
- Les LED peuvent être allumées et éteintes à l'infini sans réduire la vie.
- Les LED ne nécessitent quasiment aucun entretien, résistantes aux chocs et insensibles aux vibrations. En outre, elles ne présentent pas de temps d'attente au démarrage: vous obtenez l'intensité lumineuse totale dès que vous les allumez.
- Les LED procurent une lumière régulière et chaude et existent aussi bien avec changeur de couleur qu'avec variateur de lumière.

Principalement pour ces raisons, EGLO s'est attelé intensivement au sujet de la LED pour la saison 2011/2012 et a constitué une large palette de produits qui a quelque chose à proposer à chacun : de la lampe suspendue design à la lampe de table tendance, en passant par le plafonnier polyvalent.

Was Sie noch über unsere LED-Produkte wissen sollten: What else you can learn from our LED products: Ce qu'il y a encore à savoir sur les LED:



1200lm

Energiebedarf ist nicht gleich Lichtausbeute!

Zusätzlich zur Wattage finden Sie deshalb bei vielen unserer LED-Produkte die Lichtausbeute (= Lumen), damit Sie noch besser vergleichen können! (z.B. eine herkömmliche Glühbirne mit 40 Watt entspricht im Lichtausbeute-Vergleich einem LED-Leuchtmittel mit ca. 8 Watt!)

Energy intensive is not the same thing as bright!

That is why, in addition to quoting their wattage, many of our LED products state their light yield (lumen) so that you can make an even better comparison! (e.g. a conventional 40 watt bulb is comparable with an 8 watt LED light in light yield terms!)

L'efficacité lumineuse n'est pas proportionnelle au besoin d'énergie!

C'est pourquoi, concernant le wattage, beaucoup de nos produits à LED indiquent également l'efficacité lumineuse (= lumen) afin que vous puissiez encore mieux comparer ! (par exemple, si on compare l'efficacité lumineuse, une ampoule traditionnelle de 40 Watt correspond à une LED de 8 Watt !)



LEDs für alle Lichtstimmungen!

Grundsätzlich sind alle unsere LED-Produkte mit warm-weißen LEDs ausgestattet. Zusatzfunktionen wie Farbwechsler, Fernbedienung, Dimmbarkeit, etc. sind gesondert ausgewiesen.

LEDs for all your lighting needs!

All of our LED products are fitted with warm white LEDs as standard. Additional functions, such as colour changers, remote controls, dimmer switches, etc. are shown separately.

Des LED pour tous les goûts!

Tous nos produits à LED sont équipés de LED blanc chaud. Les fonctions supplémentaires telles que le changeur de couleur, la télécommande, le variateur de lumière, etc. sont fournies séparément.



Zusätzlich bieten wir vor allem im Bereich Wand und Decke viele Artikel an, die über LEDs als Deko-Funktion verfügen.

We also offer many items featuring decorative LEDs, particularly in the wall and ceiling ranges.

Principalement dans le domaine mur et plafond, nous proposons également de nombreux articles qui disposent de LED comme fonction de décoration.



LED für jedes Einsatzgebiet!

Vor allem dem Energiespar-Faktor Rechnung tragend haben wir viele unserer Standard-Wand- und Deckenleuchten ebenfalls auf die LED-Technologie umgestellt. Besonders praktisch: Einige dieser Produkte verfügen zusätzlich über einen integrierten, unsichtbaren Hochfrequenzsensor zum Einstellen von Zeit, Helligkeit und Reichweite (S. 28 - 35).

LEDs can be used anywhere!

For mainly energy saving reasons, many of our standard wall and ceiling lights have been converted to LED technology. What is particularly practical is that some of these products also contain an integrated high frequency sensor for you to set the time, brightness and range (p. 28 - 35).

La LED dans chaque domaine d'application!

Principalement en raison du facteur d'économie d'énergie, nous avons fait appel à la technologie de la LED pour un grand nombre de nos lampes murales et plafonniers standard. Encore plus pratique: certains de ces produits disposent en plus d'un capteur à haute fréquence intégré afin de régler la durée, la luminosité et l'autonomie (voir 28 - 35).

Aber auch unser neues LED-Stripes-Sortiment lässt in Sachen Anwendungsvielfalt keine Wünsche offen! (S. 62 - 69).

Our new and extensive LED stripes range also covers every possible desire (p. 62 - 69).

Notre nouvelle gamme de bandes LED répond également à toutes les exigences en matière de variété d'applications ! (voir 62 - 69).



Qualität hat Vorrang!

Unsere Produkte erfüllen die strenge Norm ENEC 60598, alle unsere LED-Leuchtmittel sind TÜV SÜD zertifiziert und entsprechen allen Umweltauflagen.

Quality is key!

Our products meet the strict ENEC 60598 regulation, all of our LED illuminants are TÜV SÜD certified and comply with all corresponding environmental requirements.

Priorité à la qualité!

Nos produits répondent aux exigences de la stricte norme ENEC 60598, toutes nos ampoules à LED sont certifiées par le service TÜV SÜD et respectent toutes les obligations environnementales.

Information ist Vorsprung!

Noch mehr Informationen zu den aktuellen LED-Highlights erhalten Sie in unseren Konsumentenfoldern.

Find out more!

Further information about current LED highlights is available in our consumer files.

L'information est un plus!

Vous trouverez encore plus d'informations sur les actuels incontournables de la LED dans notre espace consommateur.

CARDITO

01 90928 - CARDITO

Hängeleuchte; Alu, Stahl, chrom / Glas, Kristall
 pendant lamp; aluminium, steel, chrome / glass, crystal
 lampe suspension; aluminium, acier, chrome / verre, cristal
 L 700, H 1100



9 002759 909284



1x 24,96W 510 lm
 (156 LED)

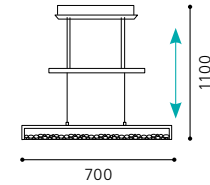

GL2497
 inklusive Leuchtmittel | bulbs included | ampoules comprises

02 90929 - CARDITO

Hängeleuchte; Alu, Stahl, chrom / Glas, Kristall
 pendant lamp; aluminium, steel, chrome / glass, crystal
 lampe suspension; aluminium, acier, chrome / verre, cristal
 L 1000, B 80, H 1100



9 002759 909291



1x 36,48W 745 lm
 (228 LED)

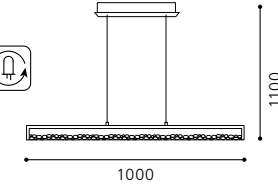

GL2530
 inklusive Leuchtmittel | bulbs included | ampoules comprises



GL2497

01 90928

GL2530

02 90929

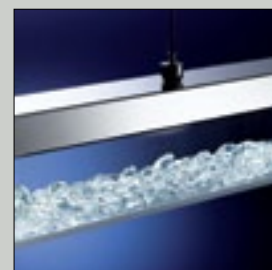

Moderne Designer-Leuchte mit hochwertigen Glas-Kristallen.

Modern designer pendant lamp with high quality glass crystals.

Chandelier design moderne avec des cristaux de verre de haute qualité.

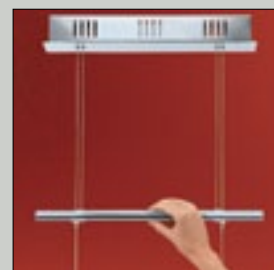

Durch praktisches Zugpendel in der Höhe verstellbar.

Flexible in height with practical adjustable drawbar.

Réglable en hauteur avec un système monte et baisse.

01

AINA + TORIO



01 90781 - AINA

Hängeleuchte; Alu, Stahl, chrom / Kunststoff, weiß
 pendant lamp; aluminium, steel, chrome / plastic, white
 lampe suspension; aluminium, acier, chrome / plastique, blanc

L 750, B 80, H 1100



9 40027591 90781 5



1x 13,44W 274 lm
 (84 LED)

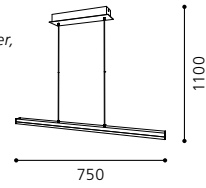

03 90935 - TORIO

Hängeleuchte; Alu gebürstet, Stahl, chrom / Kunststoff, weiß
 pendant lamp; aluminium brushed, steel, chrome / plastic, white
 lampe suspension; aluminium brossé, acier, chrome / plastique, blanc

L 650, H 1100



9 40027591 90935 2



8x 2,38W 960 lm

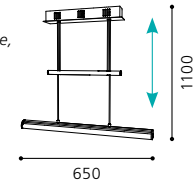

inklusive Leuchtmittel | bulbs included | ampoules comprises

inklusive Leuchtmittel | bulbs included | ampoules comprises

02 90899 - AINA

Hängeleuchte; Alu, Stahl, chrom / Kunststoff, weiß
 pendant lamp; aluminium, steel, chrome / plastic, white
 lampe suspension; aluminium, acier, chrome / plastique, blanc

L 1000, B 80, H 1100



9 40027591 90899 7



1x 18,24W 372 lm
 (114 LED)

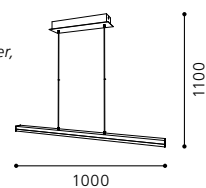

04 90936 - TORIO

Hängeleuchte; Alu gebürstet, Stahl, chrom / Kunststoff, weiß
 pendant lamp; aluminium brushed, steel, chrome / plastic, white
 lampe suspension; aluminium brossé, acier, chrome / plastique, blanc

L 900, H 1100



9 40027591 90936 9



10x 2,38W 1200 lm

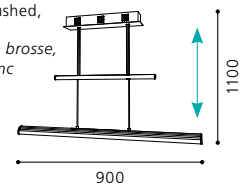

inklusive Leuchtmittel | bulbs included | ampoules comprises

inklusive Leuchtmittel | bulbs included | ampoules comprises



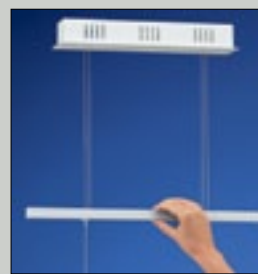

Durch praktisches Zugpendel in der Höhe verstellbar.

Flexible in height with practical adjustable drawbar.

Réglable en hauteur avec un système monte et baisse.

03 04

AGOSTA + FELITTO + TIGHT



01 91067 - AGOSTA

Hängeleuchte; Alu, Stahl, schwarz / Glas satiniert, klar
 pendant lamp; aluminium, steel, black / satinated glass, clear
 lampe suspension; aluminium, acier, noir / verre satiné, clair
 L 845, H 1100

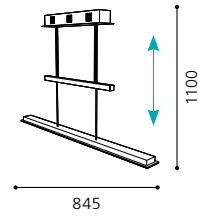
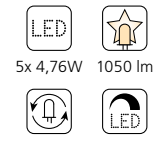

GL2507
 inklusive Leuchtmittel | bulbs included | ampoules comprises

02 91078 - FELITTO

Hängeleuchte; Alu, Stahl, weiß glänzend / Glas satiniert
 pendant lamp; aluminium, steel, shiny white / satinated glass
 lampe suspension; aluminium, acier, blanc brillant / verre satiné
 L 910, B 150, H 1100

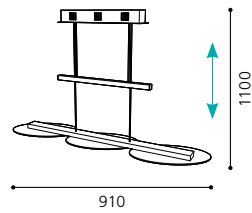
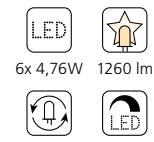

GL2508
 inklusive Leuchtmittel | bulbs included | ampoules comprises

03 91068 - TIGHT

Hängeleuchte; Alu, Stahl, antik-braun / Glas satiniert
 pendant lamp; aluminium, steel, brown antique / satinated glass
 lampe suspension; aluminium, acier, marron antique / verre satiné
 L 890, B 100, H 1100

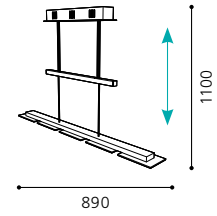
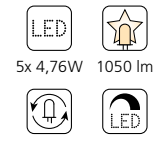

GL2495
 inklusive Leuchtmittel | bulbs included | ampoules comprises

04 91071 - TIGHT

Hängeleuchte; Alu, Stahl, weiß glänzend / Glas satiniert
 pendant lamp; aluminium, steel, shiny white / satinated glass
 lampe suspension; aluminium, acier, blanc brillant / verre satiné
 L 890, B 100, H 1100

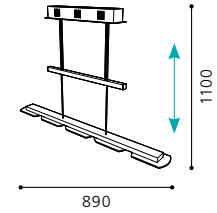
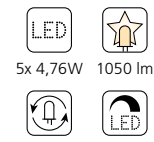

GL2496
 inklusive Leuchtmittel | bulbs included | ampoules comprises



Durch praktisches Zugpendel in der Höhe verstellbar.

Flexible in height with practical adjustable drawbar.

Réglable en hauteur avec un système monte et baisse.

RUFO + MYSTERIO



01 90817 - RUFO

Hängeleuchte; Alu, Stahl, chrom / Glas satiniert, klar
pendant lamp; aluminium, steel, chrome / satinated glass, clear
lampe suspension; aluminium, acier, chrome / verre satiné, clair

L 900, H 1100



1x 25,92W (81 LED) 529 lm

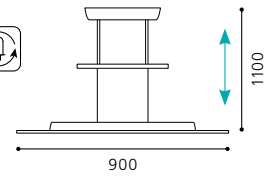

GL2502
inklusive Leuchtmittel | bulbs included | ampoules comprises

02 90816 - RUFO

Hängeleuchte; Alu, Stahl, chrom / Glas satiniert, klar
pendant lamp; aluminium, steel, chrome / satinated glass, clear
lampe suspension; aluminium, acier, chrome / verre satiné, clair

L 650, H 1100



1x 16,32W (51 LED) 333 lm

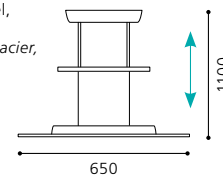

GL2501
inklusive Leuchtmittel | bulbs included | ampoules comprises

03 90913 - RUFO

Hängeleuchte; Alu, Stahl, chrom, weiß glänzend / Glas satiniert, klar
pendant lamp; aluminium, steel, chrome, shiny white / satinated glass, clear
lampe suspension; aluminium, acier, chrome, blanc brillant / verre satiné, clair

L 1000, H 1100



1x 37W (222 LED) 745 lm

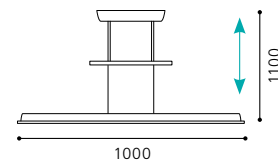

GL2529
inklusive Leuchtmittel | bulbs included | ampoules comprises

04 91079 - MYSTERIO

Hängeleuchte; Alu, Stahl, chrom / Glas satiniert, klar
pendant lamp; aluminium, steel, chrome / satinated glass, clear
lampe suspension; aluminium, acier, chrome / verre satiné, clair

L 1070, H 1100



6x 1x 5,5W (27 LED) 1260 lm 33 lm
4,76W

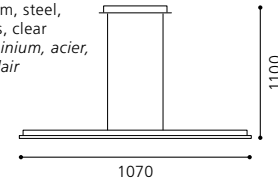

GL2510, GL2511, GL2512
inklusive Leuchtmittel | bulbs included | ampoules comprises



04

Moderne LED-Leuchte mit integriertem Farbwechsler.
Modern LED lamp with integrated colour changer.
Lampe moderne LED avec changeur de couleur intégré.



Durch praktisches Zugpendel in der Höhe verstellbar.

Flexible in height with practical adjustable drawbar.

Réglable en hauteur avec un système monte et baisse.

01 02 03

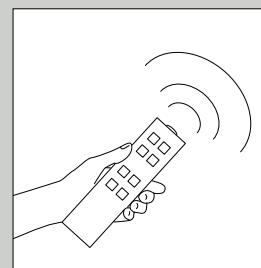

Diese Leuchte kann bequem per Fernbedienung gesteuert werden (im Lieferumfang enthalten).

This lamp can be comfortably operated with a remote control (included with the lamp).

Cette lampe peut être contrôlée avec une télécommande (incluse avec la lampe).

04

SALVO + PULSANO



01 91076 - SALVO

Hängeleuchte; Alu, Stahl,
weiß glänzend / Glas satiniert, klar
pendant lamp; aluminium, steel,
shiny white / satinated glass, clear
lampe suspension; aluminium, acier,
blanc brillant / verre satiné, clair

L 780, B 80, H 1100

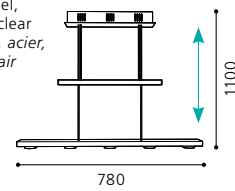

5x 1050 lm
4,76W

GL2524, GL2526

inklusive Leuchtmittel | bulbs included | ampoules comprises

02 91077 - SALVO

Hängeleuchte; Alu, Stahl,
weiß glänzend / Glas satiniert, klar
pendant lamp; aluminium, steel,
shiny white / satinated glass, clear
lampe suspension; aluminium, acier,
blanc brillant / verre satiné, clair

L 1070, H 1100

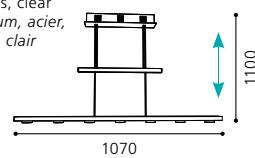

7x 1470 lm
4,76W

GL2525, GL2526

inklusive Leuchtmittel | bulbs included | ampoules comprises

03 90933 - PULSANO

Hängeleuchte; Stahl, nickel-matt /
Glas Wischtechnik, weiß
pendant lamp; steel, nickel matt /
wipe technique glass, white
lampe suspension; acier, nickel mat /
verre technique à l'essuyé, blanc

L 725, H 1100

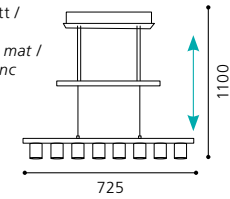

8x 960 lm
2,38W

GL2490

inklusive Leuchtmittel | bulbs included | ampoules comprises

04 90934 - PULSANO

Hängeleuchte; Stahl, nickel-matt /
Glas Wischtechnik, weiß
pendant lamp; steel, nickel matt /
wipe technique glass, white
lampe suspension; acier, nickel mat /
verre technique à l'essuyé, blanc

L 905, H 1100

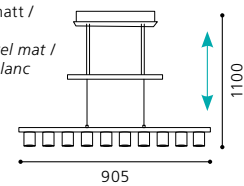

10x 1200 lm
2,38W

GL2490

inklusive Leuchtmittel | bulbs included | ampoules comprises





Handgemachtes Glas mit spezieller Wischtechnik.
Handmade glass with special wipe technique.
Verre de luxe fait main avec technique à l'essuyé.

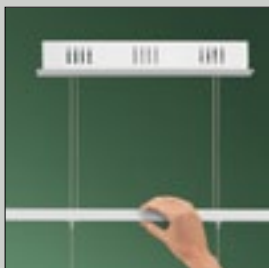

Durch praktisches Zugpendel in der Höhe verstellbar.
Flexible in height with practical adjustable drawbar.
Réglable en hauteur avec un système monte et baisse.

03
04

HAILEY + ALENTO



01 91358 - HAILEY

Hängeleuchte; Stahl, chrom / Glas satiniert, klar
 pendant lamp; steel, chrome / satinated glass, clear
 lampe suspension; acier, chrome / verre satiné, clair
 H 1100, Ø 55; Base: Ø 120

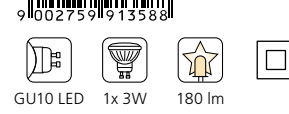

GL2355
 inklusive Leuchtmittel | bulbs included | ampoules comprises

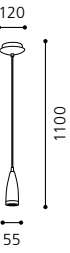

02 91359 - HAILEY

Hängeleuchte; Stahl, chrom / Glas satiniert, klar
 pendant lamp; steel, chrome / satinated glass, clear
 lampe suspension; acier, chrome / verre satiné, clair
 L 680, B 55, H 1100

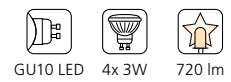

GL2355
 inklusive Leuchtmittel | bulbs included | ampoules comprises

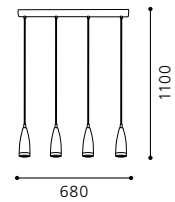

03 91117 - ALENTO

Hängeleuchte; Stahl, weiß glänzend / Glas satiniert
 pendant lamp; steel, shiny white / satinated glass
 lampe suspension; acier, blanc brillant / verre satiné
 L 1090, H 1100

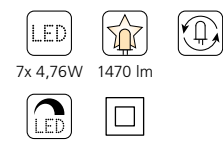

GL2658
 inklusive Leuchtmittel | bulbs included | ampoules comprises

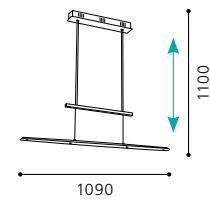

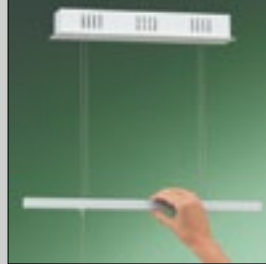

Durch praktisches Zugpendel in der Höhe verstellbar.

Flexible in height with practical adjustable drawbar.

Réglable en hauteur avec un système monte et baisse.

03

AGGIUS



01 91545 - AGGIUS

Hängeleuchte; Stahl, chrom / Glas satiniert, klar
pendant lamp; steel, chrome / satinated glass, clear
lampe suspension; acier, chrome / verre satiné, clair

H 1100, Ø 150

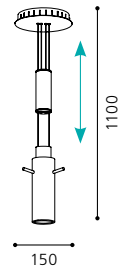
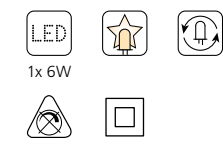

GL2719
inklusive Leuchtmittel | bulbs included | ampoules comprises

02 91546 - AGGIUS

Hängeleuchte; Stahl, chrom / Glas satiniert, klar
pendant lamp; steel, chrome / satinated glass, clear
lampe suspension; acier, chrome / verre satiné, clair

L 870, H 1100

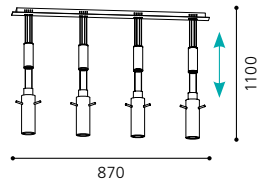

GL2719
inklusive Leuchtmittel | bulbs included | ampoules comprises

03 91547 - AGGIUS

Wandleuchte; Stahl, chrom / Glas satiniert, klar
wall lamp; steel, chrome / satinated glass, clear
applique; acier, chrome / verre satiné, clair

L 70, H 380, A 110

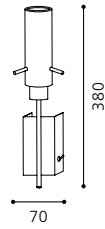
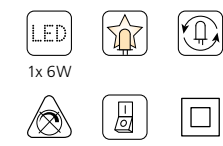

GL2719
inklusive Leuchtmittel | bulbs included | ampoules comprises

04 91548 - AGGIUS

Tischleuchte; Stahl, chrom / Glas satiniert, klar
table lamp; steel, chrome / satinated glass, clear
lampe de table; acier, chrome / verre satiné, clair

H 420, Ø 120

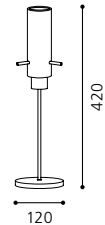
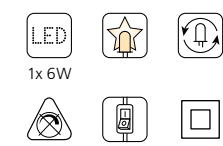

GL2719
inklusive Leuchtmittel | bulbs included | ampoules comprises



Durch praktisches Zugpendel in der Höhe verstellbar.

Flexible in height with practical adjustable drawbar.

Réglable en hauteur avec un système monte et baisse.

01 02

BOOTES



01 90807 - BOOTES

Hängeleuchte; Stahl, nickel-matt / Glas satiniert, klar
 pendant lamp; steel, nickel matt / satinated glass, clear
 lampe suspension; acier, nickel mat / verre satiné, clair
 H 1100, Ø 200

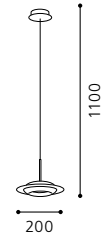
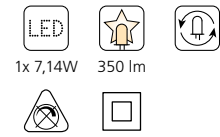

GL2517
 inklusive Leuchtmittel | bulbs included | ampoules comprises

02 90808 - BOOTES

Hängeleuchte; Stahl, nickel-matt / Glas satiniert, klar
 pendant lamp; steel, nickel matt / satinated glass, clear
 lampe suspension; acier, nickel mat / verre satiné, clair
 L 740, B 200, H 1100

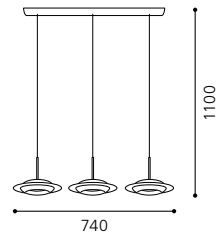
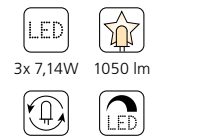

GL2517
 inklusive Leuchtmittel | bulbs included | ampoules comprises

03 90811 - BOOTES

Hängeleuchte; Stahl, nickel-matt / Glas satiniert, klar
 pendant lamp; steel, nickel matt / satinated glass, clear
 lampe suspension; acier, nickel mat / verre satiné, clair
 H 1100, Ø 480

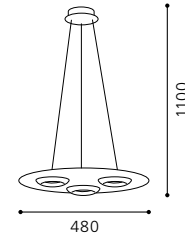
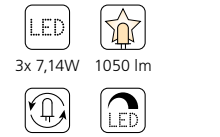

GL2518
 inklusive Leuchtmittel | bulbs included | ampoules comprises

04 90809 - BOOTES

Hängeleuchte; Stahl, nickel-matt / Glas satiniert, klar
 pendant lamp; steel, nickel matt / satinated glass, clear
 lampe suspension; acier, nickel mat / verre satiné, clair
 L 950, B 200, H 1100

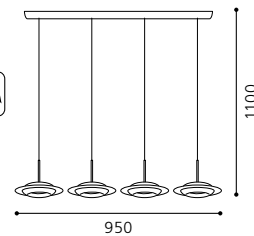
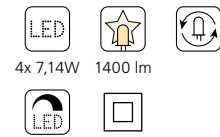

GL2517
 inklusive Leuchtmittel | bulbs included | ampoules comprises



GL2517

01 90807

GL2518

03 90811

02 90808

GL2517



GL2517

04 90809

PRIVERO + SANIA 1 + TANO + CELENZA



01 90922 - PRIVERO

Wand-/ Deckenleuchte; Stahl, chrom / Glas geätzt
 wall / ceiling lamp; steel, chrome / corroded glass
 applique / plafonnier; acier, chrome / verre rouillé
 L 950, B 415, A 50



GL2503
 inklusive Leuchtmittel | bulbs included | ampoules comprises

02 91348 - SANIA 1

Wand-/ Deckenleuchte; Stahl, chrom, weiß glänzend
 wall / ceiling lamp; steel, chrome, shiny white
 applique / plafonnier; acier, chrome, blanc brillant
 L 245, H 170, A 85

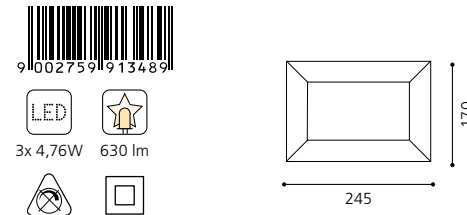

inklusive Leuchtmittel | bulbs included | ampoules comprises

03 91229 - SANIA 1

Wandleuchte; Stahl, chrom, weiß glänzend
 wall lamp; steel, chrome, shiny white
 applique; acier, chrome, blanc brillant
 L 240, H 160, A 95

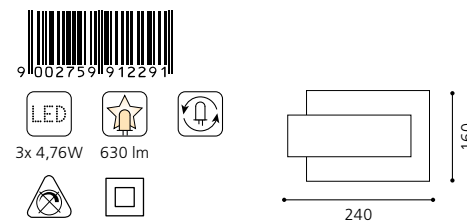

inklusive Leuchtmittel | bulbs included | ampoules comprises

04 90639 - TANO

Wandleuchte; Stahl, chrom / Glas satiniert, klar
 wall lamp; steel, chrome / satinated glass, clear
 applique; acier, chrome / verre satiné, clair
 L 330, H 180, A 60

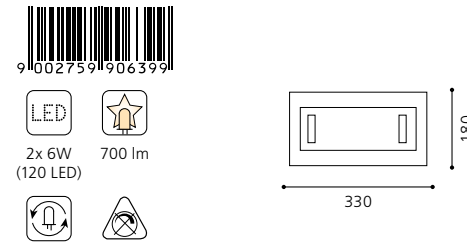

GL2401
 inklusive Leuchtmittel | bulbs included | ampoules comprises

05 90942 - CELENZA

Deckenleuchte; Stahl, nickel-matt / Glas satiniert, klar
 ceiling lamp; steel, nickel matt / satinated glass, clear
 plafonnier; acier, nickel mat / verre satiné, clair
 Ø 400, A 105

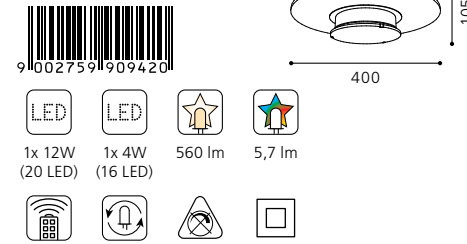

GL2503, GL2521
 inklusive Leuchtmittel | bulbs included | ampoules comprises



02 91348



03 91229



04 90639

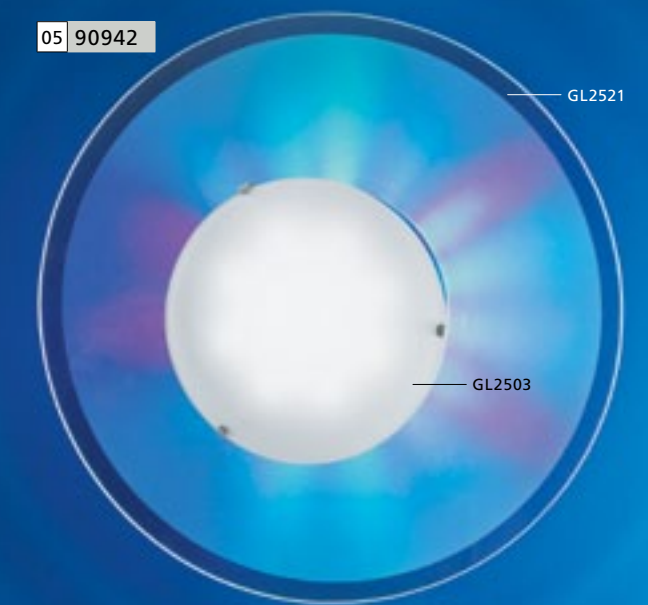

05 90942

LED | PRIVERO + SANIA 1 + TANO + CELENZA



Diese Leuchte kann bequem per Fernbedienung gesteuert werden (im Lieferumfang enthalten).

This lamp can be comfortably operated with a remote control (included with the lamp).

Cette lampe peut être contrôlée avec une télécommande (incluse avec la lampe).

05

05

05



01 91826 - ABIDA

Wandleuchte; Stahl, weiß / Glas satiniert
wall lamp; steel, white / satinated glass
applique; acier, blanc / verre satiné
L 90, H 160, A 45

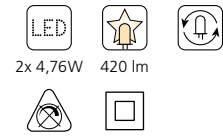

2x 4,76W 420 lm

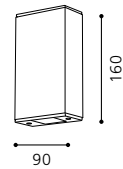

GL2666
inklusive Leuchtmittel | bulbs included | ampoules comprises

02 91827 - ABIDA

Wandleuchte; Stahl, weiß / Glas satiniert
wall lamp; steel, white / satinated glass
applique; acier, blanc / verre satiné
L 200, H 160, A 45

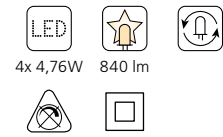

4x 4,76W 840 lm

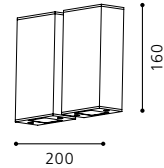

GL2666
inklusive Leuchtmittel | bulbs included | ampoules comprises

03 91559 - ABIDA

Wandleuchte; Stahl, chrom / Glas satiniert
wall lamp; steel, chrome / satinated glass
applique; acier, chrome / verre satiné
L 90, H 160, A 45

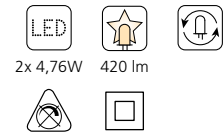

2x 4,76W 420 lm

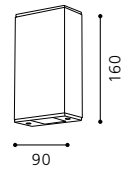

GL2666
inklusive Leuchtmittel | bulbs included | ampoules comprises

04 91561 - ABIDA

Wandleuchte; Stahl, chrom / Glas satiniert
wall lamp; steel, chrome / satinated glass
applique; acier, chrome / verre satiné
L 200, H 160, A 45

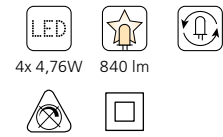

4x 4,76W 840 lm

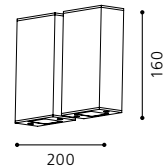

GL2666
inklusive Leuchtmittel | bulbs included | ampoules comprises

02 91827



01 91826



04 91561



03 91559



GL2666

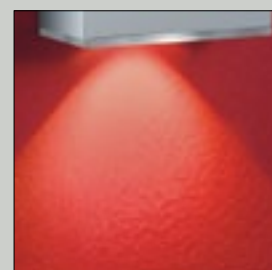

Diese Leuchten erzeugen einen einmaligen Lichteffect.

These lamps create a unique light effect.

Ces lampes créent un effet lumineux unique.

LED AREZZO + LED AURIGA



01 91853 - LED AREZZO

Wand-/ Deckenleuchte; Stahl, nickel-matt / Glas satiniert
 wall / ceiling lamp; steel, nickel matt / satinated glass
 applique / plafonnier; acier, nickel mat / verre satiné
 Ø 345, A 78

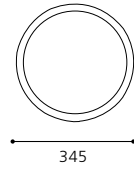
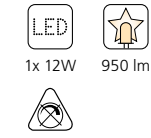

GL-281
 inklusive Leuchtmittel | bulbs included | ampoules comprises

02 91854 - LED AREZZO

Wand-/ Deckenleuchte; Stahl, nickel-matt / Glas satiniert
 wall / ceiling lamp; steel, nickel matt / satinated glass
 applique / plafonnier; acier, nickel mat / verre satiné
 Ø 425, A 95

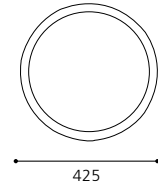
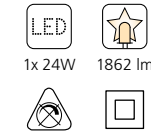

GL1348
 inklusive Leuchtmittel | bulbs included | ampoules comprises

03 91683 - LED AURIGA

Wand-/ Deckenleuchte; Stahl, nickel-matt / Glas satiniert
 wall / ceiling lamp; steel, nickel matt / satinated glass
 applique / plafonnier; acier, nickel mat / verre satiné
 L 300, B 300, A 65

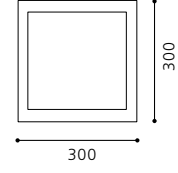
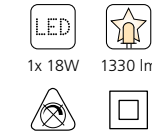

GL-943, GL-944
 inklusive Leuchtmittel | bulbs included | ampoules comprises

04 91684 - LED AURIGA

Wand-/ Deckenleuchte; Stahl, nickel-matt / Glas satiniert
 wall / ceiling lamp; steel, nickel matt / satinated glass
 applique / plafonnier; acier, nickel mat / verre satiné
 L 385, B 385, A 65

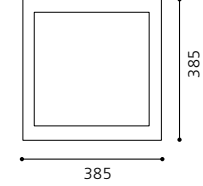
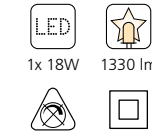

GL-945, GL-946
 inklusive Leuchtmittel | bulbs included | ampoules comprises

01 91853

04 91684

03 91683

02 91854

GL-281

GL-943

GL-944

GL-945

GL-946

GL1348

LED GIRON + LED BARI 1 + LED MALVA + LED AERO 2



01 91672 - LED GIRON

Wand-/ Deckenleuchte; Stahl, weiß / Kunststoff, weiß
 wall / ceiling lamp; steel, white / plastic, white
applique / plafonnier; acier, blanc / plastique, blanc
 Ø 385, A 120

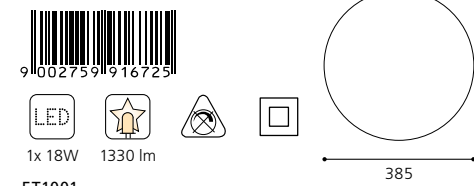

ET1001
 inklusive Leuchtmittel | bulbs included | ampoules comprises

02 91685 - LED BARI 1

Wand-/ Deckenleuchte; Stahl, weiß / Glas opal
 wall / ceiling lamp; steel, white / opal glass
applique / plafonnier; acier, blanc / verre opale
 Ø 350, A 110

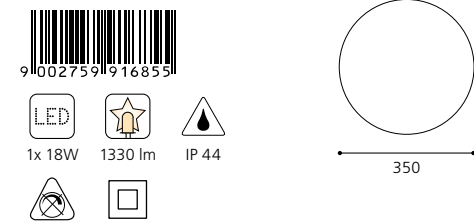

GL2185
 inklusive Leuchtmittel | bulbs included | ampoules comprises

03 91682 - LED MALVA

Wand-/ Deckenleuchte; Stahl, weiß / Glas Wischtechnik, weiß
 wall / ceiling lamp; steel, white / wipe technique glass, white
applique / plafonnier; acier, blanc / verre technique à l'essuyé, blanc
 Ø 315, A 95



GL2176
 inklusive Leuchtmittel | bulbs included | ampoules comprises

04 91851 - LED AERO 2

Wand-/ Deckenleuchte; Stahl, nickel-matt / Glas satiniert
 wall / ceiling lamp; steel, nickel matt / satinated glass
applique / plafonnier; acier, nickel mat / verre satiné
 L 340, B 340, A 94

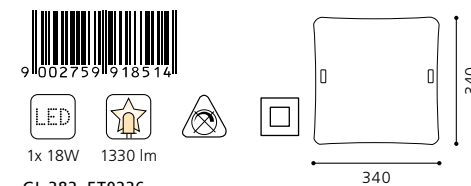

GL-382, ET0236
 inklusive Leuchtmittel | bulbs included | ampoules comprises

05 91852 - LED AERO 2

Wand-/ Deckenleuchte; Stahl, nickel-matt / Glas satiniert
 wall / ceiling lamp; steel, nickel matt / satinated glass
applique / plafonnier; acier, nickel mat / verre satiné
 L 410, B 410, A 94

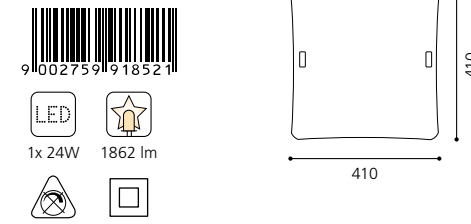

GL-598, ET0236
 inklusive Leuchtmittel | bulbs included | ampoules comprises



Handgemachtes Glas mit spezieller Wischtechnik.

Handmade glass with special wipe technique.

Verre de luxe fait main avec technique à l'essuyé.

03



LED AURIGA + LED CORRIENTE + LED TOLEDA



01 91668 - LED AURIGA

Wand-/ Deckenleuchte; Stahl, nickel-matt /
Glas satiniert
wall / ceiling lamp; steel, nickel matt /
satinated glass
applique / plafonnier; acier, nickel mat /
verre satiné

L 300, B 300, A 65

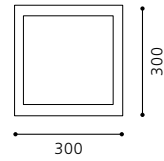

1x 18W 1330 lm

GL-943, GL-944

inklusive Leuchtmittel | bulbs included | ampoules comprises

02 91669 - LED AURIGA

Wand-/ Deckenleuchte; Stahl, nickel-matt / Glas satiniert
wall / ceiling lamp; steel, nickel matt / satinated glass
applique / plafonnier; acier, nickel mat / verre satiné

L 385, B 385, A 65

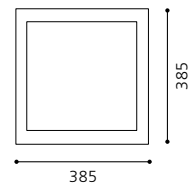

1x 18W 1330 lm

GL-945, GL-946

inklusive Leuchtmittel | bulbs included | ampoules comprises

03 91708 - LED CORRIENTE

Wand-/ Deckenleuchte; Stahl, weiß /
Glas lackiert, weiß, klar
wall / ceiling lamp; steel, white /
coated glass, white, clear
applique / plafonnier; acier, blanc /
verre laqué, blanc, clair

L 280, B 305, A 90

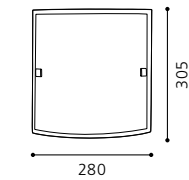

1x 18W 1330 lm

GL2726, ET1076

inklusive Leuchtmittel | bulbs included | ampoules comprises

04 91709 - LED CORRIENTE

Wand-/ Deckenleuchte; Stahl, weiß /
Glas lackiert, weiß, klar
wall / ceiling lamp; steel, white /
coated glass, white, clear
applique / plafonnier; acier, blanc /
verre laqué, blanc, clair

L 380, B 380, A 90

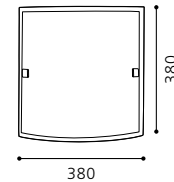

1x 24W 1862 lm

GL2516, ET1076

inklusive Leuchtmittel | bulbs included | ampoules comprises

05 91714 - LED TOLEDA

Wand-/ Deckenleuchte; Stahl, weiß /
Glas satiniert, Metall, chrom
wall / ceiling lamp; steel, white /
satinated glass, metal, chrome
applique / plafonnier; acier, blanc /
verre satiné, métal, chrome

L 410, B 410, A 98

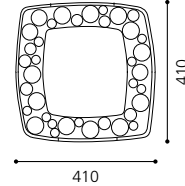

1x 18W 1330 lm

GL-598

inklusive Leuchtmittel | bulbs included | ampoules comprises

Alle Leuchten auf dieser Seite sind mit integriertem Bewegungssensor ausgestattet. Dieser ist unsichtbar hinter dem Glas befestigt.

All lamps on this page have an integrated motion sensor. This sensor is mounted invisibly behind the glass.

Tous les lampes dans cette page ont un capteur de mouvement intégré. Ce capteur est attaché invisiblement derrière le verre.

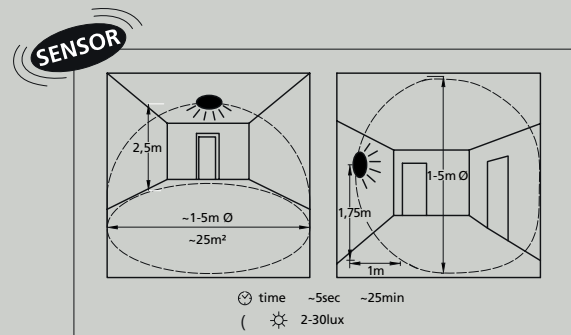

05 91714



03 91708

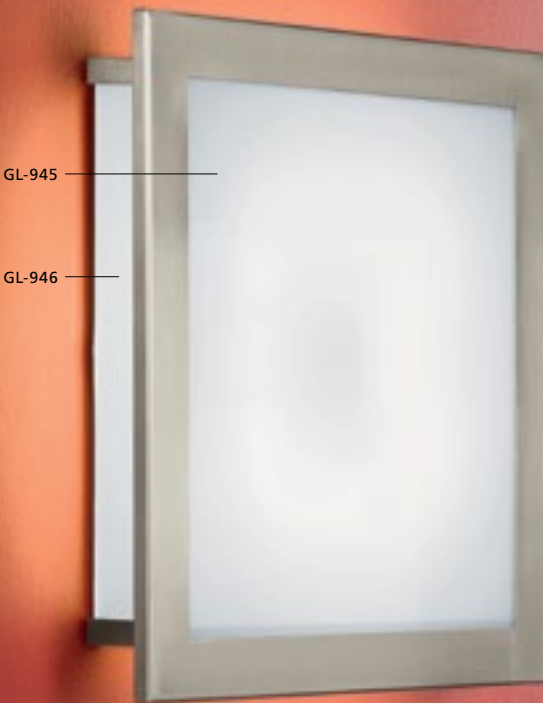

02 91669



01 91668



04 91709

GL-943

GL-944

GL2516

ET1076

LED NUBE + LED BARI 1 + LED ELLA



01 91675 - LED NUBE

Wand-/ Deckenleuchte; Stahl, weiß, chrom / Glas lackiert, weiß, klar
wall / ceiling lamp; steel, white, chrome / coated glass, white, clear
applique / plafonnier; acier, blanc, chrome / verre laqué, blanc, clair

Ø 315, A 90



9 4002759 16756



1x 18W 1330 lm

GL2538

inklusive Leuchtmittel | bulbs included | ampoules comprises

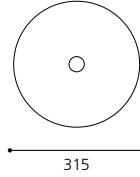

315

02 91718 - LED BARI 1

Wand-/ Deckenleuchte; Stahl, weiß / Glas opal
wall / ceiling lamp; steel, white / opal glass
applique / plafonnier; acier, blanc / verre opale

Ø 350, A 110



9 4002759 17180



1x 18W 1330 lm IP 44

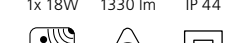

GL2185

inklusive Leuchtmittel | bulbs included | ampoules comprises

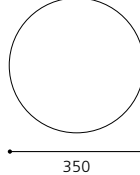

350

03 91676 - LED NUBE

Wand-/ Deckenleuchte; Stahl, weiß, chrom / Glas lackiert, weiß, klar
wall / ceiling lamp; steel, white, chrome / coated glass, white, clear
applique / plafonnier; acier, blanc, chrome / verre laqué, blanc, clair

Ø 420, A 110



9 4002759 16763



1x 18W 1330 lm

GL2539

inklusive Leuchtmittel | bulbs included | ampoules comprises

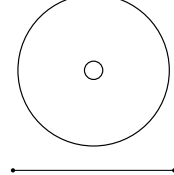

420

04 91848 - LED ELLA

Wand-/ Deckenleuchte; Stahl, weiß / Glas opal
wall / ceiling lamp; steel, white / opal glass
applique / plafonnier; acier, blanc / verre opale

Ø 450, A 125



9 4002759 18484



1x 18W 1330 lm IP 44

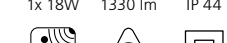

GL2373

inklusive Leuchtmittel | bulbs included | ampoules comprises

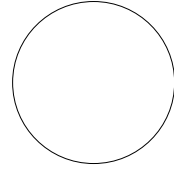

450



01 91675

02 91718

03 91676

04 91848

Alle Leuchten auf dieser Seite sind mit integriertem Bewegungssensor ausgestattet. Dieser ist unsichtbar hinter dem Glas befestigt.

All lamps on this page have an integrated motion sensor. This sensor is mounted invisibly behind the glass.

Tous les lampes dans cette page ont un capteur de mouvement intégré. Ce capteur est attaché invisiblement derrière le verre.

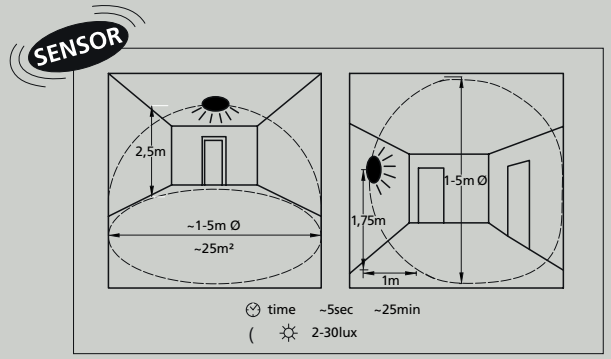

HAKANA + BADOS + DOREEN 1



01 91364 - HAKANA

Wandleuchte; Stahl, chrom / Glas satiniert
wall lamp; steel, chrome / satinated glass
applique; acier, chrome / verre satiné
L 580, H 60, A 115



9 002759 91364 9

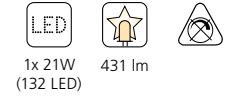

1x 21W
(132 LED) 431 lm

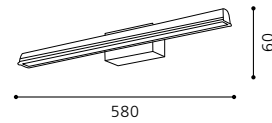

GL2695
inklusive Leuchtmittel | bulbs included | ampoules comprises

02 91365 - HAKANA

Wandleuchte; Stahl, chrom / Kunststoff, weiß
wall lamp; steel, chrome / plastic, white
applique; acier, chrome / plastique, blanc
L 580, H 60, A 120



9 002759 91365 6

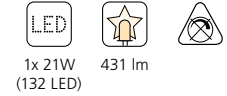

1x 21W
(132 LED) 431 lm

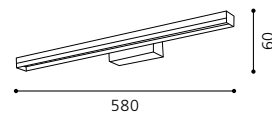

ET1198
inklusive Leuchtmittel | bulbs included | ampoules comprises

03 91366 - BADOS

Spiegelleuchte; Alu, Stahl, chrom / Glas geätzt
mirror lamp; aluminium, steel, chrome / corroded glass
lampe de miroir; aluminium, acier, chrome / verre rouillé
L 55, H 65, A 250



9 002759 91366 3

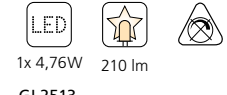

1x 4,76W 210 lm

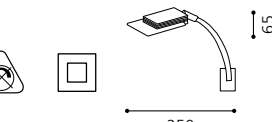

GL2513
inklusive Leuchtmittel | bulbs included | ampoules comprises

04 91367 - BADOS

Spiegelleuchte; Alu, Stahl, chrom / Glas satiniert, klar
mirror lamp; aluminium, steel, chrome / satinated glass, clear
lampe de miroir; aluminium, acier, chrome / verre satiné, clair
L 100, H 65, A 250



9 002759 91367 0

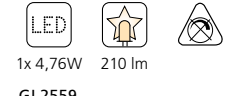

1x 4,76W 210 lm

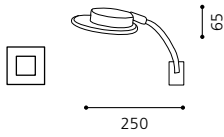

GL2559
inklusive Leuchtmittel | bulbs included | ampoules comprises

05 91648 - DOREEN 1

Spiegelleuchte; Alu, Stahl, nickel-matt
mirror lamp; aluminium, steel, nickel matt
lampe de miroir; aluminium, acier, nickel mat
L 305, H 185, A 235



9 002759 91648 0

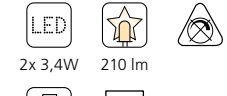

2x 3,4W 210 lm

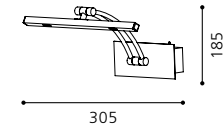

inklusive Leuchtmittel | bulbs included | ampoules comprises

06 91649 - DOREEN 1

Spiegelleuchte; Alu, Stahl, messing-matt
mirror lamp; aluminium, steel, brass matt
lampe de miroir; aluminium, acier, laiton mat
L 305, H 185, A 235



9 002759 91649 7

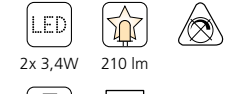

2x 3,4W 210 lm

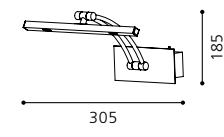

inklusive Leuchtmittel | bulbs included | ampoules comprises



01 91364



02 91365

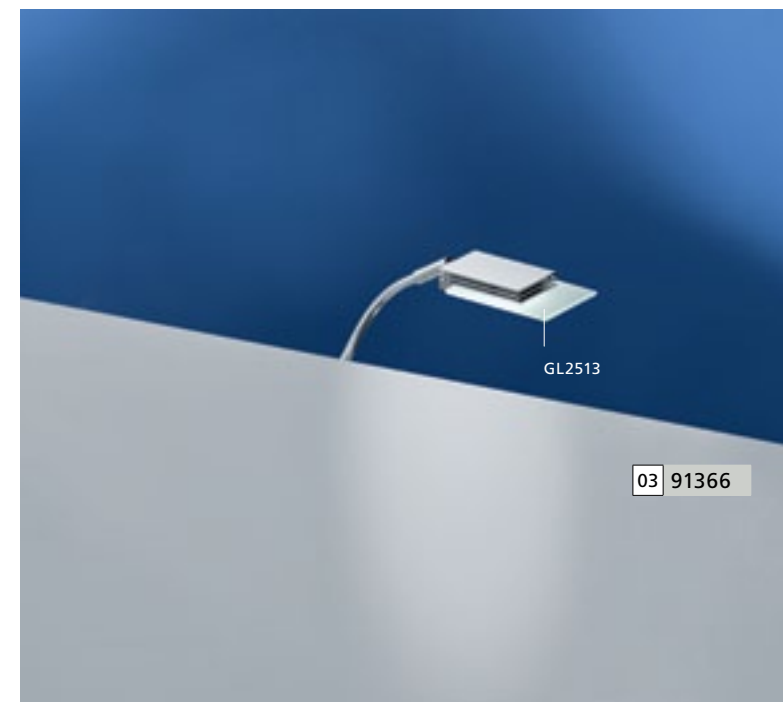

03 91366

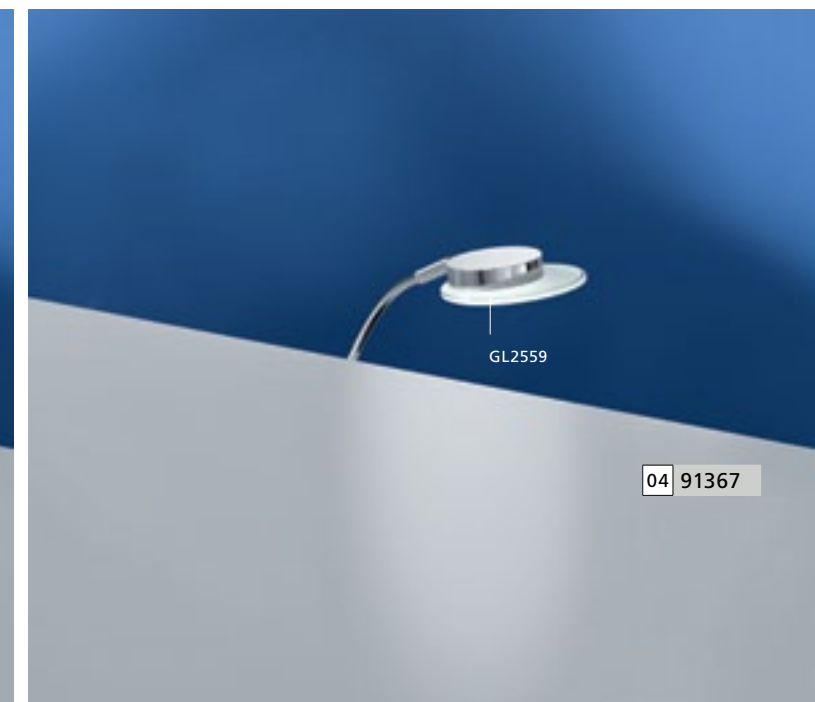

04 91367



05 91648

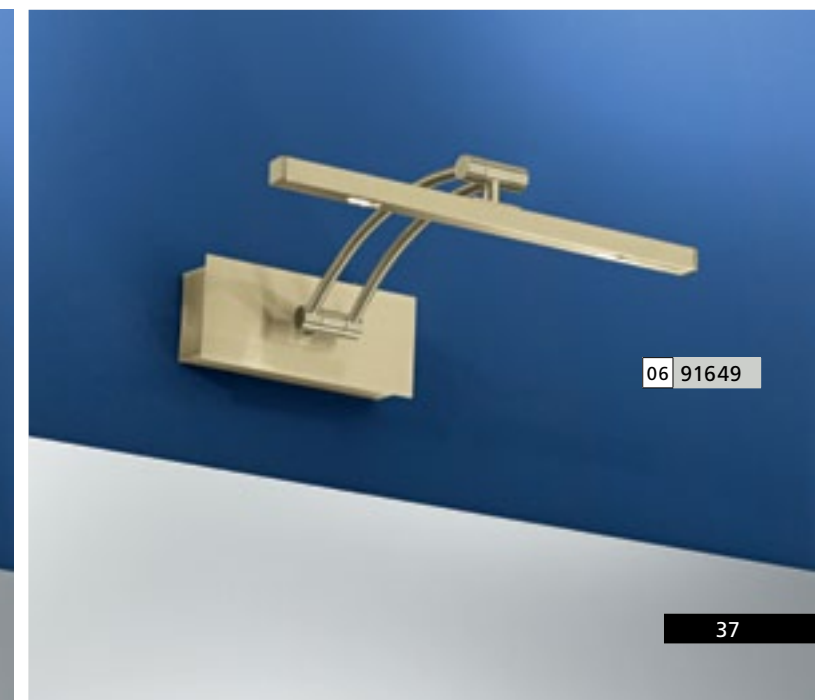

06 91649

ARON + RODEO



01 88944 - ARON

Einbauspot; Kunststoff, nickel-matt
recessed spot; plastic, nickel matt
spot encastrable; plastique, nickel mat
H 11, Ø 30

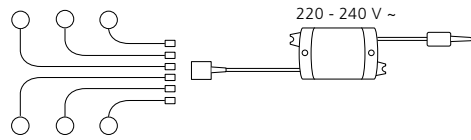
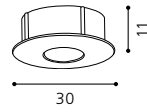

inklusive Leuchtmittel | bulbs included | ampoules comprises

02 89348 - RODEO

Einbauspot; Aluguss
recessed spot; cast aluminium
spot encastrable; aluminium moulé
Ø 45, ET 30

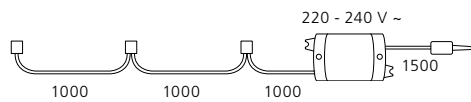
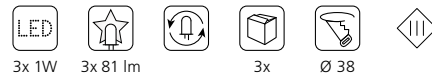
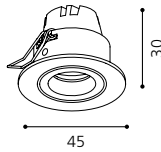

inklusive Leuchtmittel | bulbs included | ampoules comprises

03 88942 - ARON

Einbauspot; Stahl, nickel-matt
recessed spot; steel, nickel matt
spot encastrable; acier, nickel mat
Ø 85, ET 110

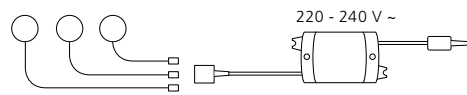
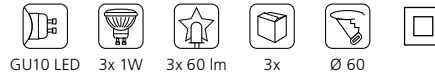
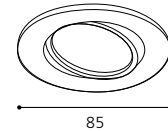

inklusive Leuchtmittel | bulbs included | ampoules comprises

04 88943 - ARON

Einbauspot; Stahl, nickel-matt
recessed spot; steel, nickel matt
spot encastrable; acier, nickel mat
Ø 90, ET 91

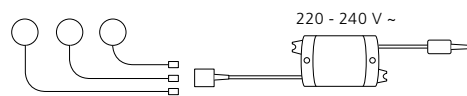
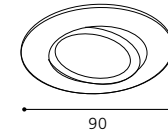

inklusive Leuchtmittel | bulbs included | ampoules comprises



01 88944

02 89348

03 88942

04 88943



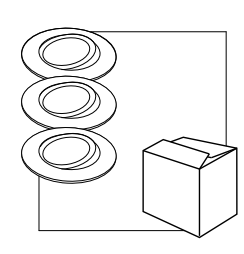

Alle Leuchten dieser Seite sind als Set erhältlich.

All lamps on this page are available as a set.

Tous les lampes on cette page sont disponibles en lot.

LOKE 1



01 91352 - LOKE 1

Wand-/ Deckenleuchte; Alu gebürstet, Stahl, chrom, schwarz
 wall / ceiling lamp; aluminium brushed, steel, chrome, black
 applique / plafonnier; aluminium brossé, acier, chrome, noir
 L 140, B 140, A 75

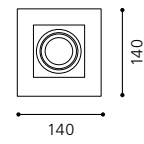
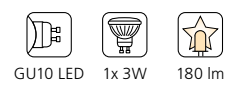

inklusive Leuchtmittel | bulbs included | ampoules comprises

02 91353 - LOKE 1

Wand-/ Deckenleuchte; Alu gebürstet, Stahl, chrom, schwarz
 wall / ceiling lamp; aluminium brushed, steel, chrome, black
 applique / plafonnier; aluminium brossé, acier, chrome, noir
 L 250, B 140, A 75

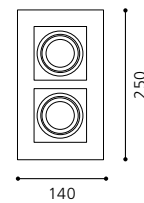
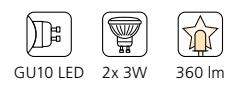

inklusive Leuchtmittel | bulbs included | ampoules comprises

03 91354 - LOKE 1

Wand-/ Deckenleuchte; Alu gebürstet, Stahl, chrom, schwarz
 wall / ceiling lamp; aluminium brushed, steel, chrome, black
 applique / plafonnier; aluminium brossé, acier, chrome, noir
 L 360, B 140, A 75

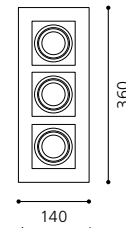
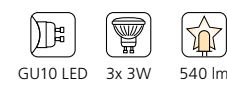

inklusive Leuchtmittel | bulbs included | ampoules comprises

04 91355 - LOKE 1

Wand-/ Deckenleuchte; Alu gebürstet, Stahl, chrom, schwarz
 wall / ceiling lamp; aluminium brushed, steel, chrome, black
 applique / plafonnier; aluminium brossé, acier, chrome, noir
 L 250, B 250, A 75

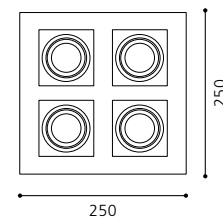
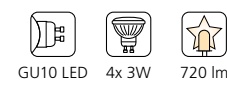

inklusive Leuchtmittel | bulbs included | ampoules comprises

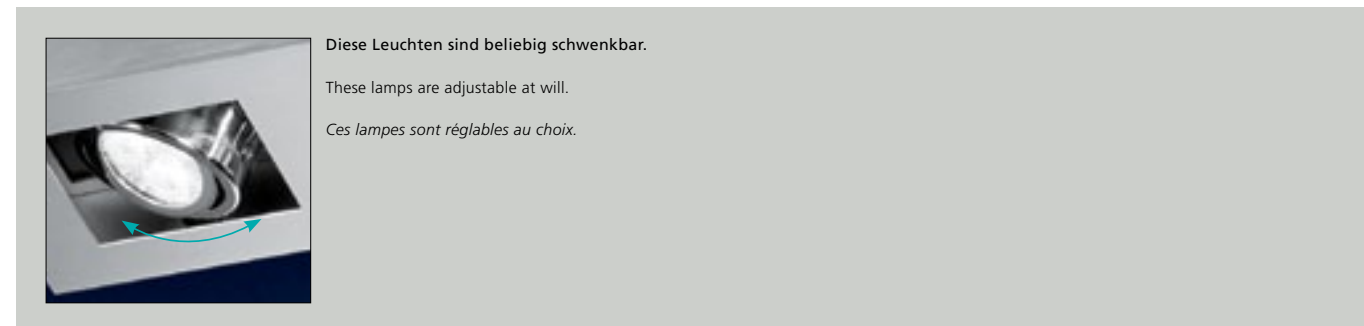

Diese Leuchten sind beliebig schwenkbar.
 These lamps are adjustable at will.
 Ces lampes sont réglables au choix.

TINNARI

01 91633 - TINNARI

Wand-/ Deckenleuchte; Alu, Stahl, chrom / Glas satiniert, klar
 wall / ceiling lamp; aluminium, steel, chrome / satinated glass, clear
 applique / plafonnier; aluminium, acier, chrome / verre satiné, clair

L 120, B 90



9 4002759 16336



1x 7,5W

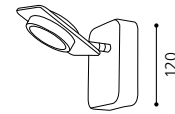

120

GL2707, GL2708

inklusive Leuchtmittel | bulbs included | ampoules comprises

02 91634 - TINNARI

Wand-/ Deckenleuchte; Alu, Stahl, chrom / Glas satiniert, klar
 wall / ceiling lamp; aluminium, steel, chrome / satinated glass, clear
 applique / plafonnier; aluminium, acier, chrome / verre satiné, clair

L 360, B 90



9 4002759 16343



2x 7,5W

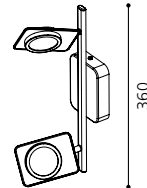

360

GL2707, GL2708

inklusive Leuchtmittel | bulbs included | ampoules comprises

03 91635 - TINNARI

Wand-/ Deckenleuchte; Alu, Stahl, chrom / Glas satiniert, klar
 wall / ceiling lamp; aluminium, steel, chrome / satinated glass, clear
 applique / plafonnier; aluminium, acier, chrome / verre satiné, clair

L 780, B 90



9 4002759 16350



4x 7,5W

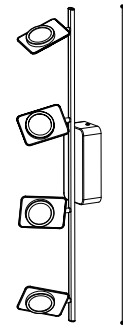

780

GL2707, GL2708

inklusive Leuchtmittel | bulbs included | ampoules comprises



01 91633



GLOSSY 1



01 91662 - GLOSSY 1

Wand-/ Deckenleuchte; Stahl, chrom / Glas geätzt
 wall / ceiling lamp; steel, chrome / corroded glass
 applique / plafonnier; acier, chrome / verre rouillé



1x 4,6W

GL2478
 inklusive Leuchtmittel | bulbs included | ampoules comprises

02 91663 - GLOSSY 1

Wand-/ Deckenleuchte; Stahl, chrom / Glas geätzt
 wall / ceiling lamp; steel, chrome / corroded glass
 applique / plafonnier; acier, chrome / verre rouillé



2x 4,6W

GL2478
 inklusive Leuchtmittel | bulbs included | ampoules comprises

03 91664 - GLOSSY 1

Wand-/ Deckenleuchte; Stahl, chrom / Glas geätzt
 wall / ceiling lamp; steel, chrome / corroded glass
 applique / plafonnier; acier, chrome / verre rouillé



4x 4,6W

GL2478
 inklusive Leuchtmittel | bulbs included | ampoules comprises



01 91662



02 91663

Eindrucksvolle LED Spotserie mit geätztem Glas.
 Impressive LED spot series with corroded glass.
 Série de spots de LED impressionnante avec un verre rouillé.

GEMINI

01 90862 - GEMINI

Wandleuchte; Alu gebürstet, Stahl, weiß glänzend / Glas satiniert, klar
wall lamp; aluminium brushed, steel, shiny white / satinated glass, clear
applique; aluminium brosse, acier, blanc brillant / verre satiné, clair

L 160, B 90



9 400275 9190862 1



1x 4,76W 210 lm

ET1039

inklusive Leuchtmittel | bulbs included | ampoules comprises

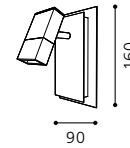

02 90863 - GEMINI

Wand-/ Deckenleuchte; Alu gebürstet, Stahl, weiß glänzend / Glas satiniert, klar
wall / ceiling lamp; aluminium brushed, steel, shiny white / satinated glass, clear
applique / plafonnier; aluminium brosse, acier, blanc brillant / verre satiné, clair

L 270, B 90



9 400275 9190863 8



2x 4,76W 420 lm

ET1039

inklusive Leuchtmittel | bulbs included | ampoules comprises

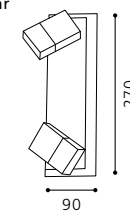

03 90864 - GEMINI

Wand-/ Deckenleuchte; Alu gebürstet, Stahl, weiß glänzend / Glas satiniert, klar
wall / ceiling lamp; aluminium brushed, steel, shiny white / satinated glass, clear
applique / plafonnier; aluminium brosse, acier, blanc brillant / verre satiné, clair

L 230, B 230



9 400275 9190864 5



4x 4,76W 840 lm

ET1039

inklusive Leuchtmittel | bulbs included | ampoules comprises

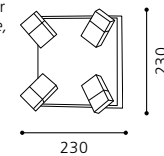

04 90865 - GEMINI

Wand-/ Deckenleuchte; Alu gebürstet, Stahl, weiß glänzend / Glas satiniert, klar
wall / ceiling lamp; aluminium brushed, steel, shiny white / satinated glass, clear
applique / plafonnier; aluminium brosse, acier, blanc brillant / verre satiné, clair

L 975, B 110



9 400275 9190865 2



4x 4,76W 840 lm

ET1075

inklusive Leuchtmittel | bulbs included | ampoules comprises

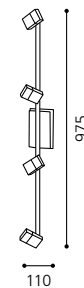

ROTTELO

01 90914 - ROTTELO

Wand-/ Deckenleuchte; Stahl, nickel-matt, chrom
wall / ceiling lamp; steel, nickel matt, chrome
applique / plafonnier; acier, nickel mat, chrome
L 120, B 60



9 40027591 90914 7

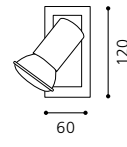

inklusive Leuchtmittel | bulbs included | ampoules comprises

02 90915 - ROTTELO

Wand-/ Deckenleuchte; Stahl, nickel-matt, chrom
wall / ceiling lamp; steel, nickel matt, chrome
applique / plafonnier; acier, nickel mat, chrome
L 280, B 70



9 40027591 90915 4

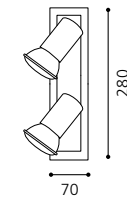
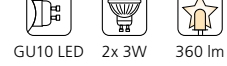

inklusive Leuchtmittel | bulbs included | ampoules comprises

03 90916 - ROTTELO

Wand-/ Deckenleuchte; Stahl, nickel-matt, chrom
wall / ceiling lamp; steel, nickel matt, chrome
applique / plafonnier; acier, nickel mat, chrome
L 260, B 240



9 40027591 90916 1

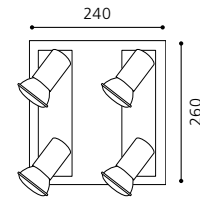

inklusive Leuchtmittel | bulbs included | ampoules comprises

04 90917 - ROTTELO

Wand-/ Deckenleuchte; Stahl, nickel-matt, chrom
wall / ceiling lamp; steel, nickel matt, chrome
applique / plafonnier; acier, nickel mat, chrome
L 780, B 70



9 40027591 90917 8

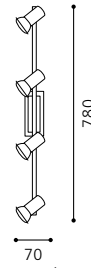

inklusive Leuchtmittel | bulbs included | ampoules comprises

05 90927 - ROTTELO

Wand-/ Deckenleuchte; Stahl, nickel-matt, chrom
wall / ceiling lamp; steel, nickel matt, chrome
applique / plafonnier; acier, nickel mat, chrome
L 1160, B 70



9 40027591 90927 7

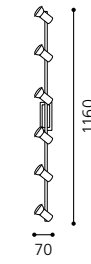

inklusive Leuchtmittel | bulbs included | ampoules comprises



04 90917

01 90914

02 90915

05 90927

03 90916

ERIDAN



01 90822 - ERIDAN

Wandleuchte; Stahl, nickel-matt
wall lamp; steel, nickel matt
applique; acier, nickel mat
L 165, B 70



inklusive Leuchtmittel | bulbs included | ampoules comprises

02 90824 - ERIDAN

Wand-/ Deckenleuchte; Stahl, nickel-matt
wall / ceiling lamp; steel, nickel matt
applique / plafonnier; acier, nickel mat
L 390, B 70



inklusive Leuchtmittel | bulbs included | ampoules comprises

03 90825 - ERIDAN

Wand-/ Deckenleuchte; Stahl, nickel-matt
wall / ceiling lamp; steel, nickel matt
applique / plafonnier; acier, nickel mat
L 580, B 70



inklusive Leuchtmittel | bulbs included | ampoules comprises

04 90823 - ERIDAN

Wandleuchte; Stahl, nickel-matt
wall lamp; steel, nickel matt
applique; acier, nickel mat
L 70, H 200, A 200

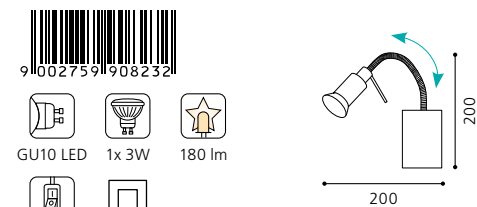

inklusive Leuchtmittel | bulbs included | ampoules comprises

05 90826 - ERIDAN

Wand-/ Deckenleuchte; Stahl, nickel-matt
wall / ceiling lamp; steel, nickel matt
applique / plafonnier; acier, nickel mat
L 885, B 70

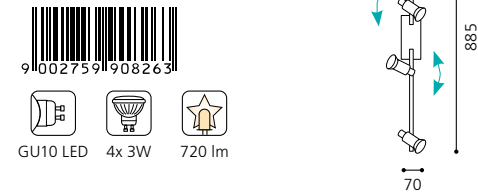

inklusive Leuchtmittel | bulbs included | ampoules comprises

06 90827 - ERIDAN

Wand-/ Deckenleuchte; Stahl, nickel-matt
wall / ceiling lamp; steel, nickel matt
applique / plafonnier; acier, nickel mat
L 1700, B 70

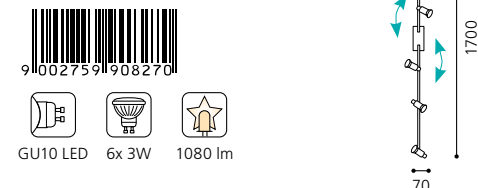

inklusive Leuchtmittel | bulbs included | ampoules comprises

07 90828 - ERIDAN

Wand-/ Deckenleuchte; Stahl, nickel-matt
wall / ceiling lamp; steel, nickel matt
applique / plafonnier; acier, nickel mat
Ø 210



inklusive Leuchtmittel | bulbs included | ampoules comprises

08 90829 - ERIDAN

Tischleuchte; Stahl, nickel-matt
table lamp; steel, nickel matt
lampe de table; acier, nickel mat
L 190, H 340; Base: Ø 125

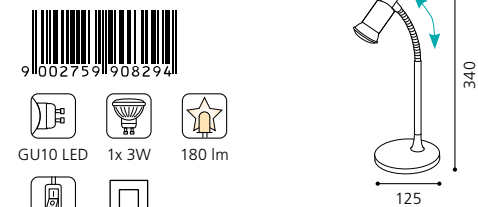

inklusive Leuchtmittel | bulbs included | ampoules comprises



01 90822

04 90823

03 90825

02 90824

07 90828

08 90829

05 90826

06 90827



01 90831 - ERIDAN

Wandleuchte; Stahl, chrom, weiß glänzend
wall lamp; steel, chrome, shiny white
applique; acier, chrome, blanc brillant

L 165, B 70

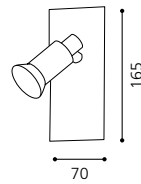

inklusive Leuchtmittel | bulbs included | ampoules comprises

02 90833 - ERIDAN

Wand-/ Deckenleuchte; Stahl, chrom, weiß glänzend
wall / ceiling lamp; steel, chrome, shiny white
applique / plafonnier; acier, chrome, blanc brillant

L 390, B 70

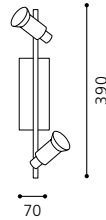
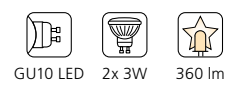

inklusive Leuchtmittel | bulbs included | ampoules comprises

03 90834 - ERIDAN

Wand-/ Deckenleuchte; Stahl, chrom, weiß glänzend
wall / ceiling lamp; steel, chrome, shiny white
applique / plafonnier; acier, chrome, blanc brillant

L 580, B 70

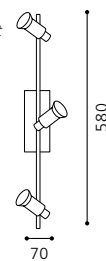
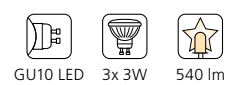

inklusive Leuchtmittel | bulbs included | ampoules comprises

04 90832 - ERIDAN

Wandleuchte; Stahl, chrom, weiß glänzend
wall lamp; steel, chrome, shiny white
applique; acier, chrome, blanc brillant

L 70, H 200, A 200

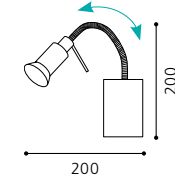
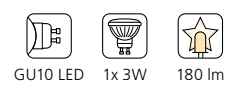

inklusive Leuchtmittel | bulbs included | ampoules comprises

05 90835 - ERIDAN

Wand-/ Deckenleuchte; Stahl, chrom, weiß glänzend
wall / ceiling lamp; steel, chrome, shiny white
applique / plafonnier; acier, chrome, blanc brillant

L 885, B 70

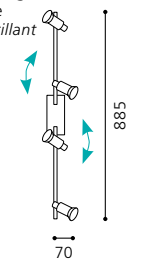
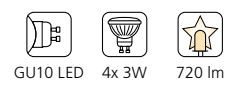

inklusive Leuchtmittel | bulbs included | ampoules comprises

06 90836 - ERIDAN

Wand-/ Deckenleuchte; Stahl, chrom, weiß glänzend
wall / ceiling lamp; steel, chrome, shiny white
applique / plafonnier; acier, chrome, blanc brillant

L 1700, B 70

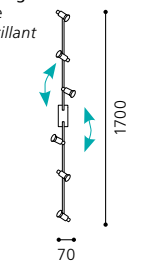
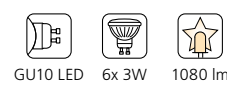

inklusive Leuchtmittel | bulbs included | ampoules comprises

07 90837 - ERIDAN

Wand-/ Deckenleuchte; Stahl, chrom, weiß glänzend
wall / ceiling lamp; steel, chrome, shiny white
applique / plafonnier; acier, chrome, blanc brillant

Ø 210

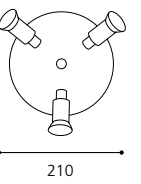
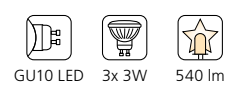

inklusive Leuchtmittel | bulbs included | ampoules comprises

08 90838 - ERIDAN

Tischleuchte; Stahl, chrom, weiß glänzend
table lamp; steel, chrome, shiny white
lampe de table; acier, chrome, blanc brillant

L 190, H 340; Base: Ø 125

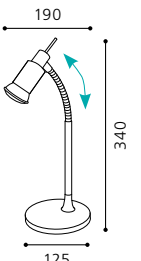
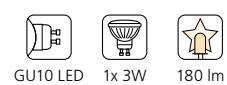

inklusive Leuchtmittel | bulbs included | ampoules comprises

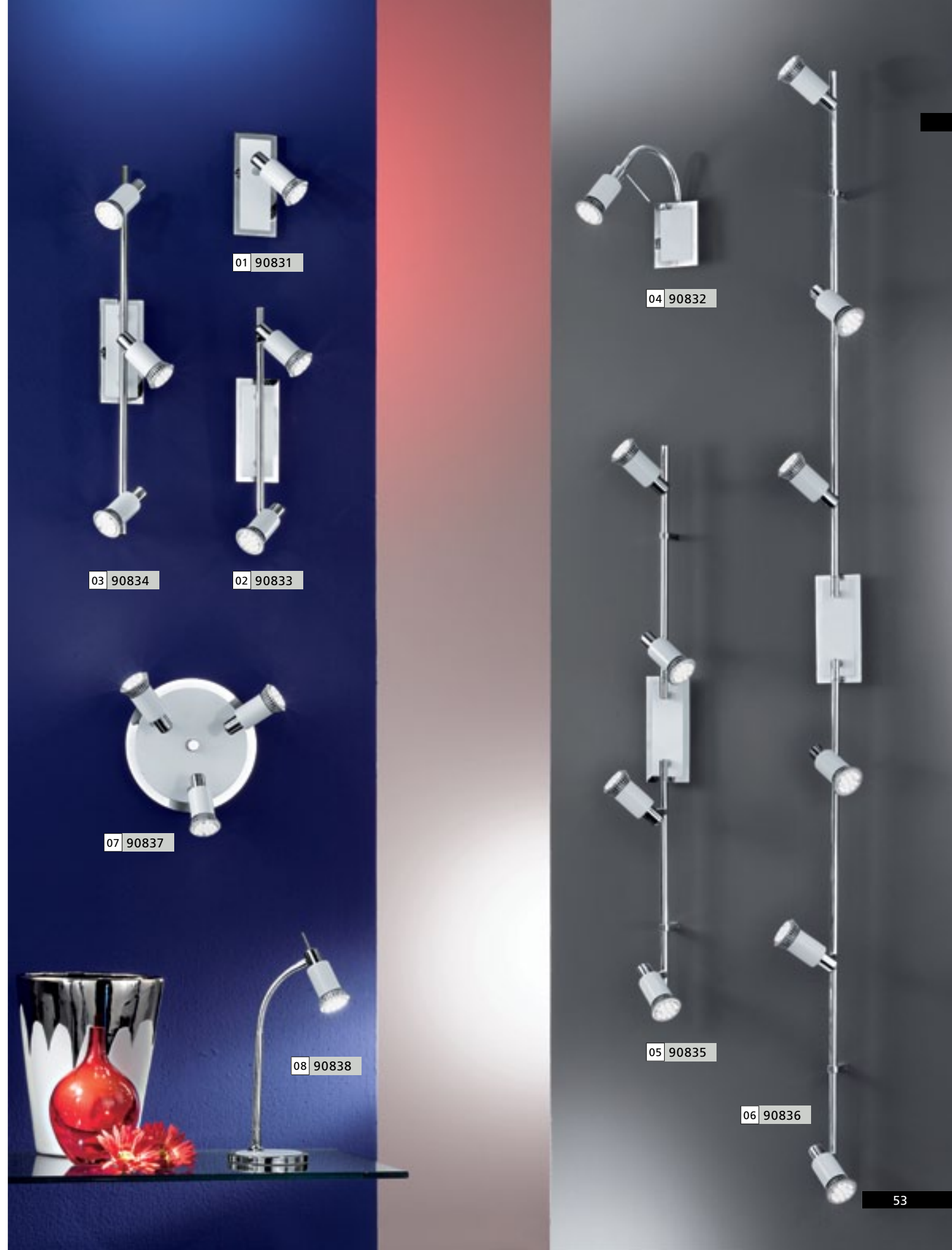

01 90831

04 90832

03 90834

02 90833

07 90837

08 90838

05 90835

06 90836

LAURIA+ ABOLI + PAN



01 90868 - LAURIA

Tischleuchte; Alu, Stahl, nickel-matt
table lamp; aluminium, steel, nickel matt
lampe de table; aluminium, acier, nickel mat

L 250, H 420

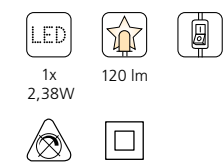

inklusive Leuchtmittel | bulbs included | ampoules comprises

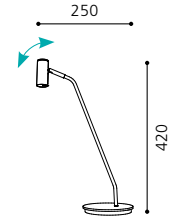

02 90869 - LAURIA

Tischleuchte; Alu, Stahl, chrom, weiß
table lamp; aluminium, steel, chrome, white
lampe de table; aluminium, acier, chrome, blanc

L 250, H 420

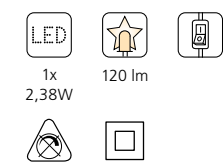

inklusive Leuchtmittel | bulbs included | ampoules comprises

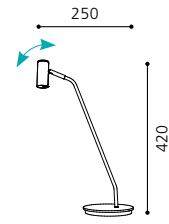

03 91645 - ABOLI

Tischleuchte; Alu, Stahl, chrom, schwarz
table lamp; aluminium, steel, chrome, black
lampe de table; aluminium, acier, chrome, noir

L 100, B 100, H 405

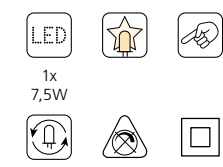

inklusive Leuchtmittel | bulbs included | ampoules comprises

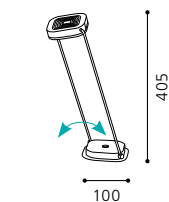

04 91644 - ABOLI

Tischleuchte; Alu, Stahl, chrom, weiß
table lamp; aluminium, steel, chrome, white
lampe de table; aluminium, acier, chrome, blanc

L 100, B 100, H 405

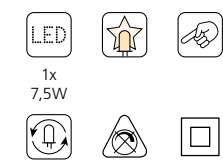

inklusive Leuchtmittel | bulbs included | ampoules comprises

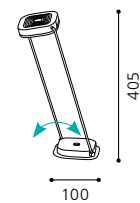

05 90769 - PAN

Tischleuchte; Alu gebürstet / Glas geätzt
table lamp; aluminium brushed / corroded glass
lampe de table; aluminium brossé / verre rouillé

L 450, H 410; Base: L 200, B 180

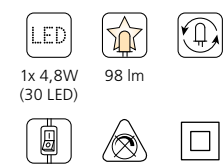

inklusive Leuchtmittel | bulbs included | ampoules comprises

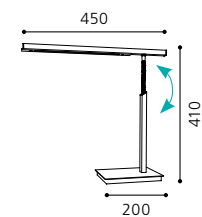

06 90768 - PAN

Tischleuchte; Alu, chrom / Glas geätzt
table lamp; aluminium, chrome / corroded glass
lampe de table; aluminium, chrome / verre rouillé

L 450, H 410; Base: L 200, B 180

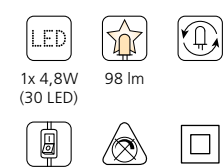

inklusive Leuchtmittel | bulbs included | ampoules comprises

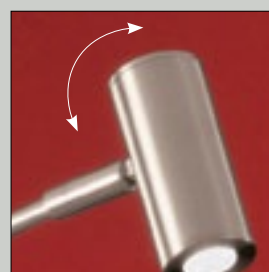
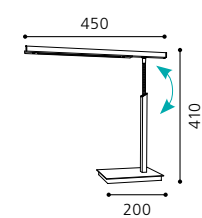

Alle Leuchten auf dieser Seite sind flexibel verstellbar.

All lamps on this page are adjustable at will.

Tous les lampes on cette page sont réglables au choix.



GLOSSY + HAYET 1 + OCASO



01 90888 - GLOSSY

Klemmleuchte; Alu, Stahl, chrom / Glas geätzt
clip lamp; aluminium, steel, chrome / corroded glass
lampe à clipper; aluminium, acier, chrome / verre rouillé
H 370

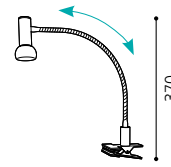
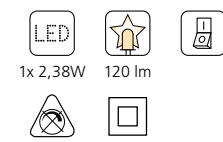

GL2478
inklusive Leuchtmittel | bulbs included | ampoules comprises

02 90882 - GLOSSY

Tischleuchte; Alu, Stahl, chrom / Glas geätzt
table lamp; aluminium, steel, chrome / corroded glass
lampe de table; aluminium, acier, chrome / verre rouillé
L 325, H 410

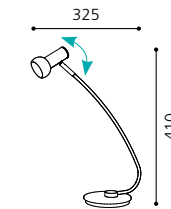
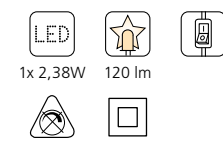

GL2478
inklusive Leuchtmittel | bulbs included | ampoules comprises

03 91239 - HAYET 1

Tischleuchte; Stahl, chrom / Glas satiniert, klar
table lamp; steel, chrome / satinated glass, clear
lampe de table; acier, chrome / verre satiné, clair
L 325, H 410

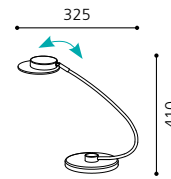
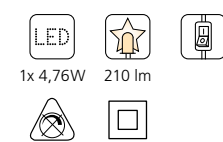

GL2559
inklusive Leuchtmittel | bulbs included | ampoules comprises

04 90889 - OCASO

Tischleuchte; Alu, Stahl, chrom / Glas geätzt
table lamp; aluminium, steel, chrome / corroded glass
lampe de table; aluminium, acier, chrome / verre rouillé
L 490, H 435

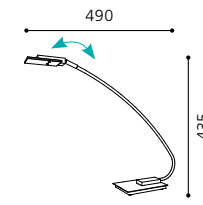
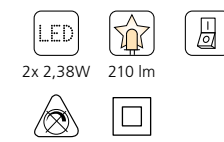

GL2513
inklusive Leuchtmittel | bulbs included | ampoules comprises

05 90892 - OCASO

Tischleuchte; Alu, Stahl, chrom, weiß glänzend / Glas geätzt
table lamp; aluminium, steel, chrome, shiny white / corroded glass
lampe de table; aluminium, acier, chrome, blanc brillant / verre rouillé
L 515, H 435

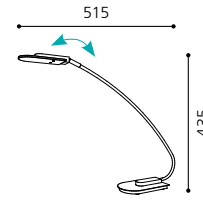
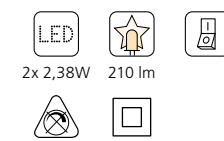

GL2514
inklusive Leuchtmittel | bulbs included | ampoules comprises

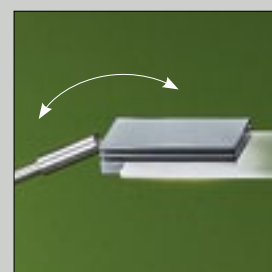

Alle Leuchten auf dieser Seite sind flexibel verstellbar.

All lamps on this page are adjustable at will.

Tous les lampes on cette page sont réglables au choix.



LIZZANO + LEPORA + XANA



01 90926 - LIZZANO

Stehleuchte; Alu, chrom / Kunststoff, weiß
 floor lamp; aluminium, chrome / plastic, white
 lampadaire; aluminium, chrome / plastique, blanc
 H 1515; Base: L 205, B 205

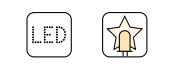

2x 15W
 (174 LED)

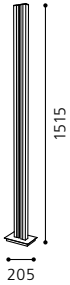

inklusive Leuchtmittel | bulbs included | ampoules comprises

02 90952 - LEPORA

Stehleuchte; Alu, chrom / Glas satiniert
 floor lamp; aluminium, chrome / satinated glass
 lampadaire; aluminium, chrome / verre satiné
 H 1510; Base: L 205, B 205



1x 19,5W 1102 lm
 (78 LED)

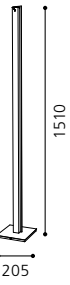

GL2498
 inklusive Leuchtmittel | bulbs included | ampoules comprises

03 91625 - XANA

Stehleuchte; Stahl, chrom / Glas satiniert, klar
 floor lamp; steel, chrome / satinated glass, clear
 lampadaire; acier, chrome / verre satiné, clair
 H 1810, Ø 380; Base: Ø 280



7x 4,76W
 1x 4,76W

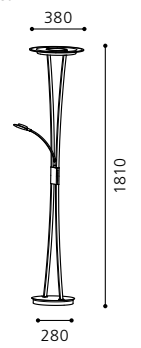

GL2732, GL2559
 inklusive Leuchtmittel | bulbs included | ampoules comprises

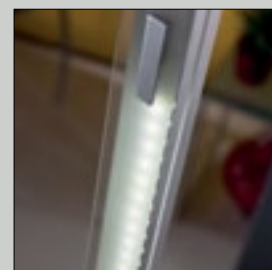

Designer-Stehleuchten mit hochwertiger LED Platine.

Designer floor lamps with high quality LED board.

Lampadaires design avec une platine des LED de haute qualité.



LACERTA 1

01 91057 - LACERTA 1

Stehleuchte; Stahl, weiß glänzend, chrom / Glas geätzt
 floor lamp; steel, shiny white, chrome / corroded glass
 lampadaire; acier, blanc brillant, chrome / verre rouillé
 L 310, B 210, H 1830



9 002759 910570



6x 4,76W 1260 lm
 1x 4,76W 210 lm

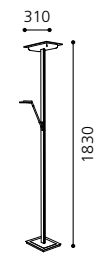

GL2513, GL2531

inklusive Leuchtmittel | bulbs included | ampoules comprises

02 91058 - LACERTA 1

Stehleuchte; Alu gebürstet, Stahl, chrom / Glas geätzt
 floor lamp; aluminium brushed, steel, chrome / corroded glass
 lampadaire; aluminium brossé, acier, chrome / verre rouillé
 L 310, B 210, H 1830



9 002759 910587



6x 4,76W 1260 lm
 1x 4,76W 210 lm

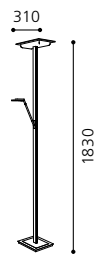

GL2513, GL2531

inklusive Leuchtmittel | bulbs included | ampoules comprises



01 91057

02 91058

LED STRIPES BASIC + LED STRIPES DECO



LED STRIPES BASIC

LED Streifen; Kunststoff, farbwechselnd, Rolle
LED stripe; plastic, colour changing, on reels
bande de LED; plastique, changeant de couleur, rouleau

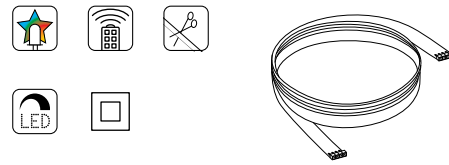

inklusive | included | compris: 3, 4
inklusive Leuchtmittel | bulbs included | ampoules comprises

01 92062
L 2000
1x 14,4W (60 LED) 1,5 m
9 002759 920623

02 92064
L 5000
1x 36W (150 LED) 1,5 m
9 002759 920647

LED STRIPES BASIC

LED Streifen; Kunststoff, Weißlicht, Rolle
LED stripe; plastic, white light, on reels
bande de LED; plastique, lumière blanche, rouleau

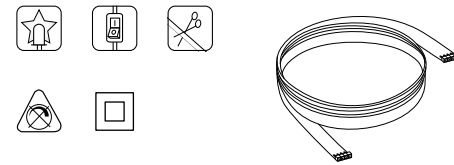

inklusive | included | compris: 1
inklusive Leuchtmittel | bulbs included | ampoules comprises

03 92061
L 2000
1x 9,6W (120 LED) 1,8 m
9 002759 920616

04 92063
L 5000
1x 24W (300 LED) 1,8 m
9 002759 920630

LED STRIPES DECO

LED Streifen; Kunststoff, Aluminiumoptik, Weißlicht, 3er Set
LED stripe; plastic, aluminium look, white light, set of 3
bande de LED; plastique, aspect d'aluminium, lumière blanche, lot de 3

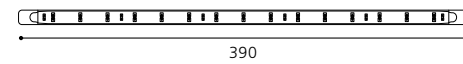

inklusive | included | compris: 2, 5, 6
inklusive Leuchtmittel | bulbs included | ampoules comprises

05 92051
3xL 390
3x 1,6W (20 LED) 2 m
9 002759 920517

Kabellänge Netzgerät (in Metern).
Length of driver cable (in meters).
Encablure du transformateur (en mètres).



inklusive Zubehör | accessories included | accessoires compris

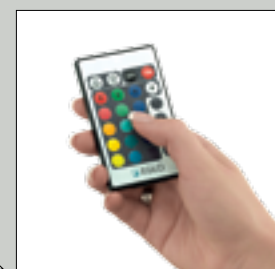
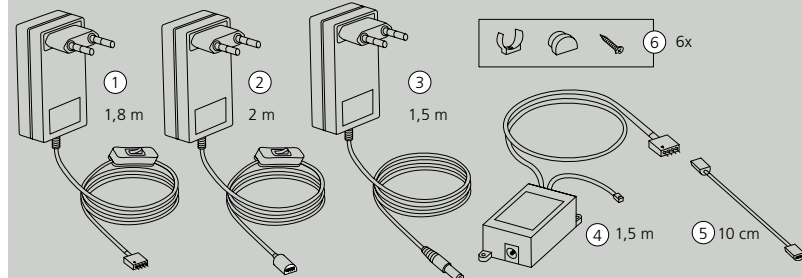

Diese Leuchten können bequem per Fernbedienung gesteuert werden (im Lieferumfang enthalten).

These lamps can be comfortably operated with a remote control (included with the lamp).

Ces lampes peuvent être contrôlées avec une télécommande (incluse avec la lampe).

01 02



01 92062

02 92064



05 92051



LED STRIPES FLEX



LED STRIPES FLEX

LED Streifen; Kunststoff, farbwechselnd
LED stripe; plastic, colour changing
bande de LED; plastique, changeant de couleur



inklusive | included | compris: 1, 3, 5, 6
inklusive Leuchtmittel | bulbs included | ampoules comprises

- 01 92052
2x L 300
2x 2,16W (9 LED) 2x 1,5 m
- 02 92054
4x L 300
4x 2,16W (9 LED) 4x 1,5 m
- 03 92056
2x L 600
2x 4,32W (18 LED) 2x 1,5 m
- 04 92058
4x L 600
4x 4,32W (18 LED) 4x 1,5 m

LED STRIPES FLEX

LED Streifen; Kunststoff, Weißlicht
LED stripe; plastic, white light
bande de LED; plastique, lumière blanche



inklusive | included | compris: 2, 4, 6
inklusive Leuchtmittel | bulbs included | ampoules comprises

- 05 92053
2x L 300
2x 1,44W (18 LED) 2x 2 m
- 06 92055
4x L 300
4x 1,44W (18 LED) 4x 2 m
- 07 92057
2x L 600
2x 2,88W (36 LED) 2x 2 m
- 08 92059
4x L 600
4x 2,88W (36 LED) 4x 2 m

Kabellänge Netzgerät (in Metern).
Length of driver cable (in meters).
Encablure du transformateur (en mètres).

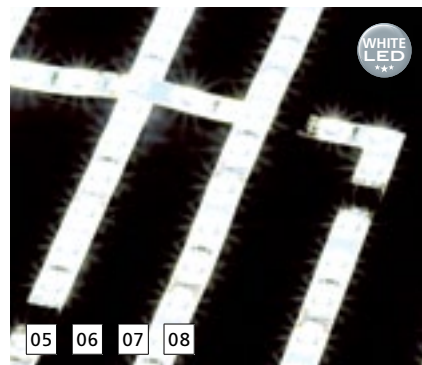
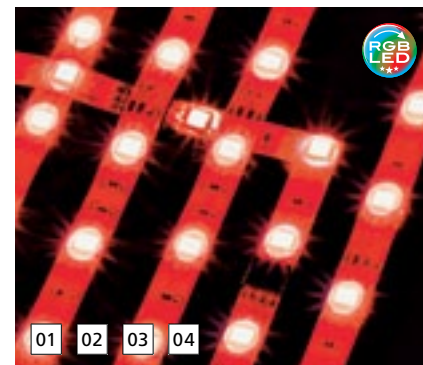
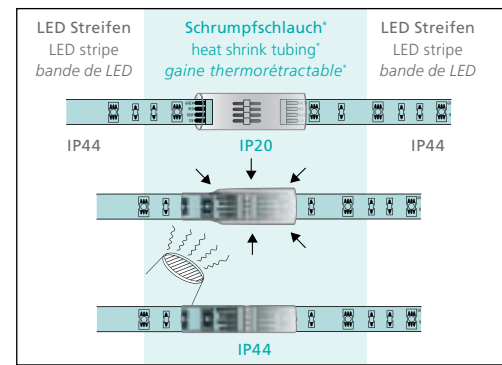

*im Zubehör inkludiert | *included in accessories | *compris au accessoires

inklusive Zubehör | accessories included | accessoires compris

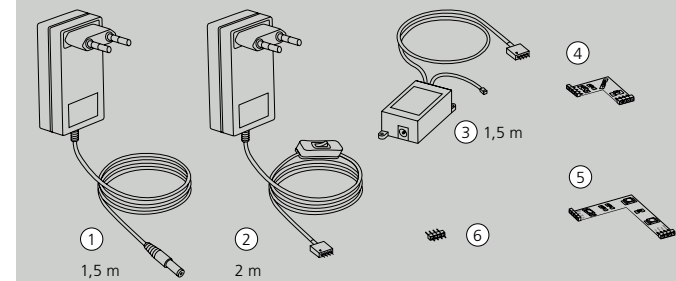

Diese Leuchten können bequem per Fernbedienung gesteuert werden (im Lieferumfang enthalten).

These lamps can be comfortably operated with a remote control (included with the lamp).

Ces lampes peuvent être contrôlées avec une télécommande (incluse avec la lampe).

01 02 03 04



- 01 92052
- 02 92054
- 03 92056
- 04 92058



LED STRIPES FLEX



LED STRIPES FLEX

LED Streifen; Kunststoff, farbwechselnd, Rolle
LED stripe; plastic, colour changing, on reels
bande de LED; plastique, changeant de couleur, rouleau

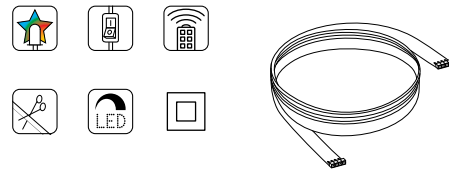

inklusive | included | compris: 1, 3
inklusive Leuchtmittel | bulbs included | ampoules comprises

01 92065

L 2000
1x 14,4W (60 LED) 1,5 m

02 92067

L 5000
1x 36W (150 LED) 1,5 m

03 92066 - LED STRIPES FLEX

LED Streifen; Kunststoff, Weißlicht, Rolle
LED stripe; plastic, white light, on reels
bande de LED; plastique, lumière blanche, rouleau

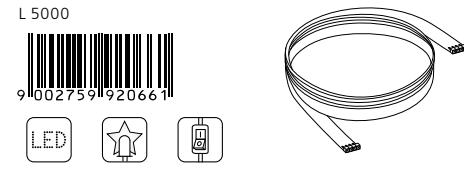

1x 24W (300 LED)

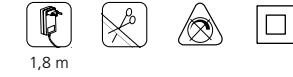

inklusive | included | comprises: 2
inklusive Leuchtmittel | bulbs included | ampoules comprises

Kabellänge Netzgerät (in Metern).
Length of driver cable (in meters).
Encablure du transformateur (en mètres).

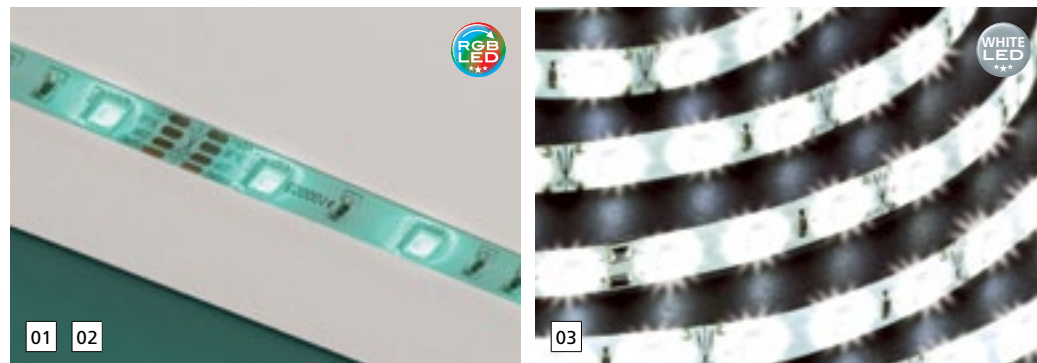

inklusive Zubehör | accessories included | accessoires compris

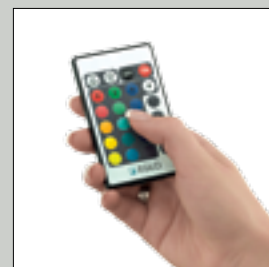
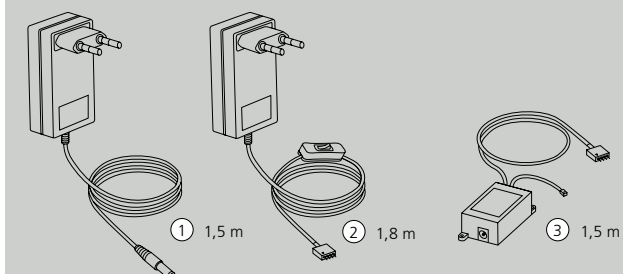

Diese Leuchten können bequem per Fernbedienung gesteuert werden (im Lieferumfang enthalten).

These lamps can be comfortably operated with a remote control (included with the lamp).

Ces lampes peuvent être contrôlées avec une télécommande (incluse avec la lampe).

01 02

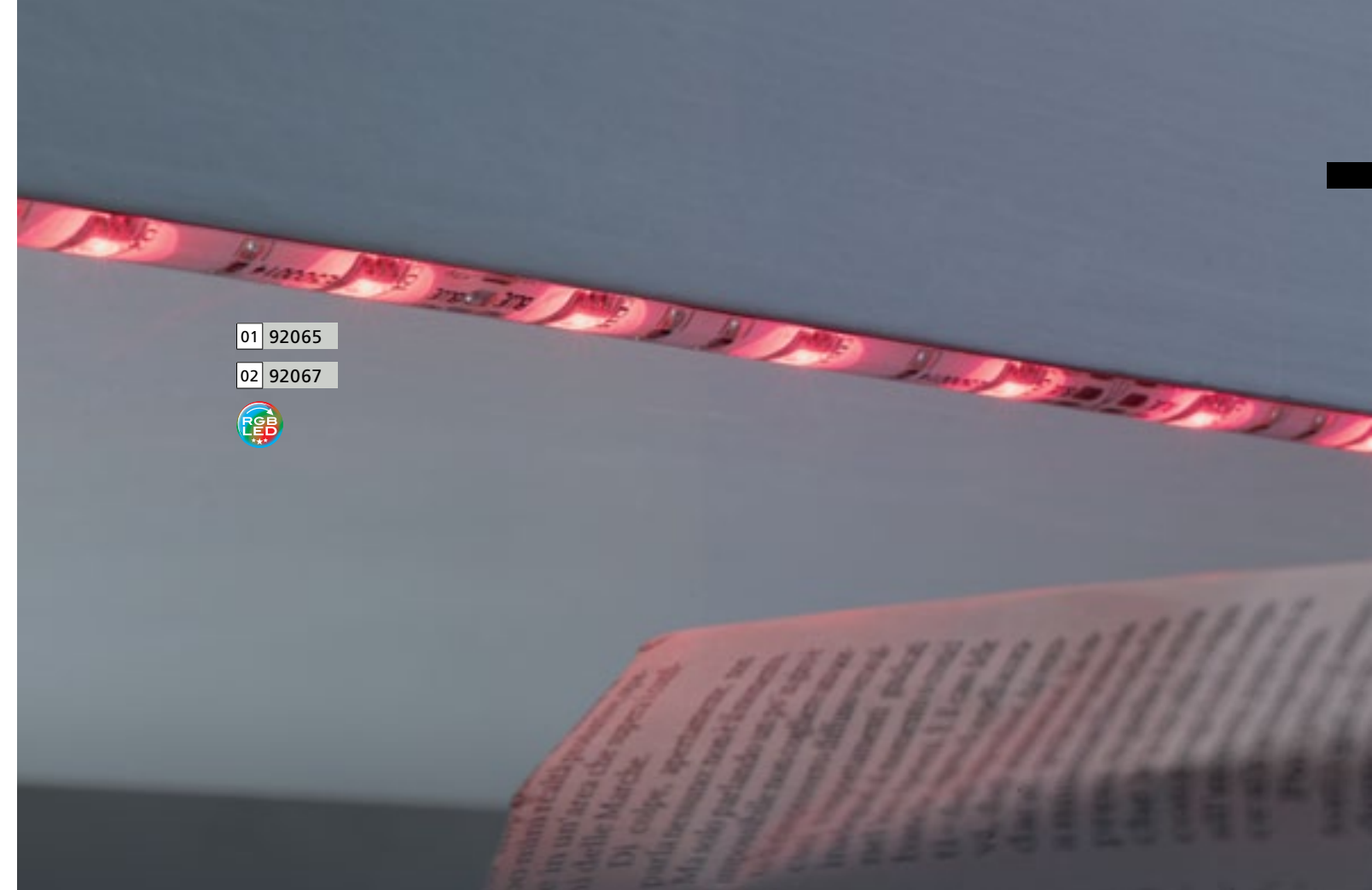

LED STRIPES SYSTEM + ZIBA



LED STRIPES SYSTEM

LED Streifen; Kunststoff, farbwechselnd
LED stripe; plastic, colour changing
bande de LED; plastique, changeant de couleur

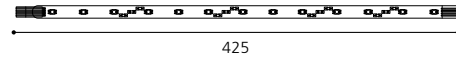

inklusive Leuchtmittel | bulbs included | ampoules comprises

01 92046

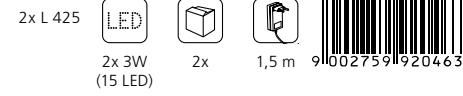

inklusive | included | compris: 3, 5, 7, 9

02 92048

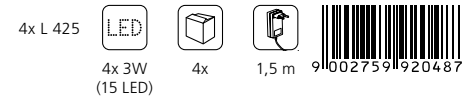

inklusive | included | compris: 3, 4, 7, 8, 9

LED STRIPES SYSTEM

LED Streifen; Kunststoff, Weißlicht
LED stripe; plastic, white light
bande de LED; plastique, lumière blanche

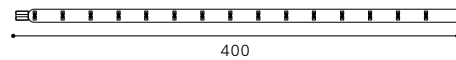

inklusive Leuchtmittel | bulbs included | ampoules comprises

03 92047

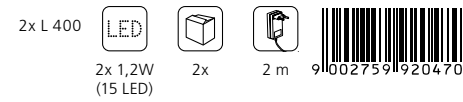

inklusive | included | compris: 1, 6, 9

04 92049

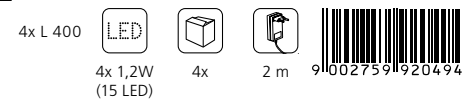

inklusive | included | compris: 2A, 6, 8, 9

ZIBA

LED Streifen; Kunststoff
LED stripe; plastic
bande de LED; plastique

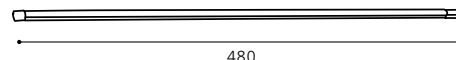

inklusive Leuchtmittel | bulbs included | ampoules comprises

05 90187

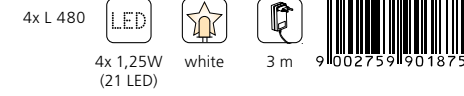

inklusive | included | compris: 2B, 7, 8, 9

06 90186

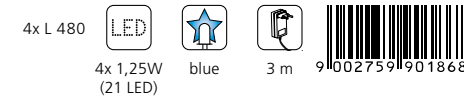

inklusive | included | compris: 2B, 7, 8, 9

Kabellänge Netzgerät (in Metern).
Length of driver cable (in meters).
Enclaire du transformateur (en mètres).

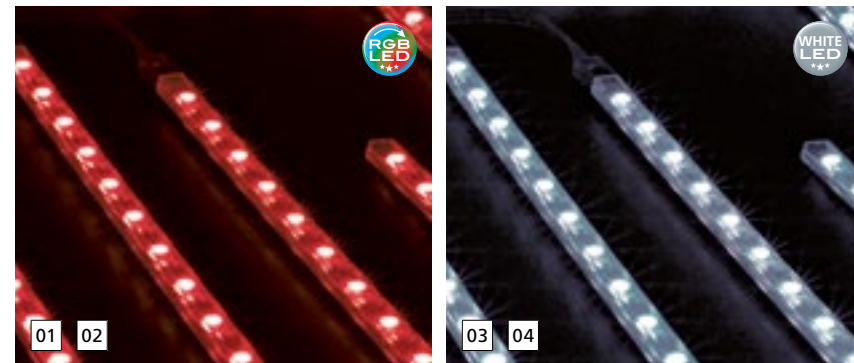

inklusive Zubehör | accessories included | accessoires compris

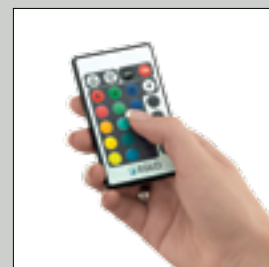
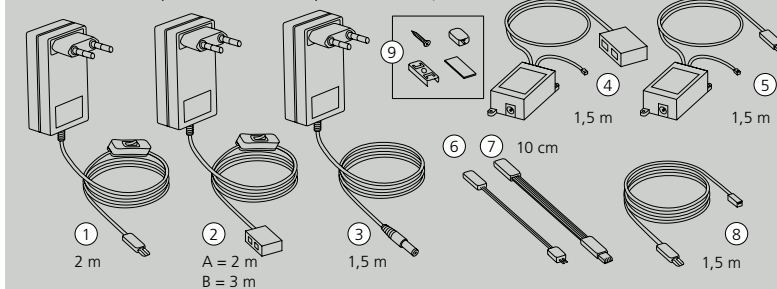

Diese Leuchten können bequem per Fernbedienung gesteuert werden (im Lieferumfang enthalten).

These lamps can be comfortably operated with a remote control (included with the lamp).

Ces lampes peuvent être contrôlées avec une télécommande (incluse avec la lampe).

01 02

